

Avrasia



**Product
Catalog**

Avrasia

index

Armature	02
Bathroom Cabinet	67
Wooden Door	109
Complementary Materials	159
Radiator	273
Natural Gas Materials	277
Plumbing Materials	314



Avrasia



Avrasia

Armature



L Series

L - 001

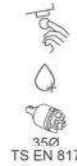
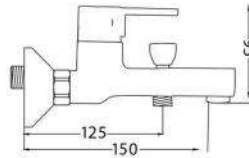

BATHROOM FAUCET

- Our product is made of MS58/MS53 brass low pressure ingots
- Surface coating is 0.16 mm chrome coating
- 25 bar pressure resistant ceramic cartridge used
- Hand shower connections are G 1/2"
- Box 12 pieces.



L - 002

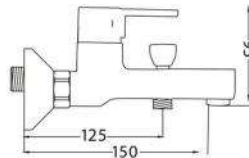

KITCHEN FAUCET

- Our product is made of MS58/MS53 brass low pressure ingots
- Surface coating is 0.16 mm chrome coating
- 25 bar pressure resistant ceramic cartridge used
- Hand shower connections are G 1/2"
- Box 12 pieces



L - 003

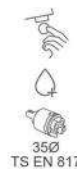
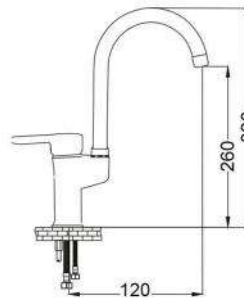

KITCHEN FAUCET

- Water saving special aerator (foam flow, lime breaker, flow rate: 8lt / min)
- Ideal working pressure 3-4 Bar
- Our product is made of MS58/MS63 brass low pressure ingots
- Surface coating is 0.16 mm chrome coating
- 360 degree rotating tube
- 25 bar pressure resistant ceramic cartridge used
- G 3/8 M-10 25 bar pressure resistant steel braided flex used
- Box 12 pieces



L - 004

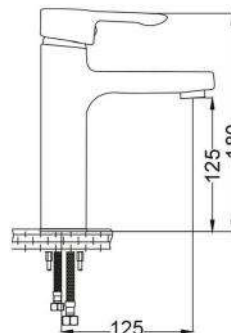

WASH BASIN FAUCET

- Water saving special aerator (foam flow, lime breaker, flow rate: 8lt / min)
- Ideal working pressure 3-4 Bar
- Our product is made of MS58/MS63 brass low pressure ingots
- Surface coating is 0.16 mm chrome coating
- 25 bar pressure resistant ceramic cartridge used
- G 3/8 M-10 25 bar pressure resistant steel braided flex used



L GOLD SERIES

LG - 001

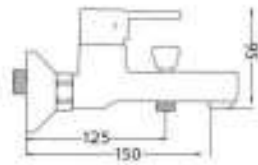

BATHROOM FAUCET

- Our product is made of H556/H563 brass low pressure ingots
- Surface coating is 0.05 mm chrome coating
- 25 bar pressure resistant ceramic cartridge used
- Hand shower connections are G 1/2
- Box 12 pieces

LG - 002

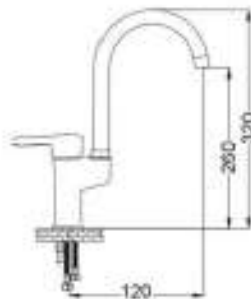

KITCHEN FAUCET

- Water saving special aerator (foam flow, line breaker, flow rate: 8l / min)
- Ideal working pressure 3-4 Bar
- Our product is made of H556/H563 brass low pressure ingots
- Surface coating is 0.05 mm chrome coating
- 360 degree rotating tube
- 25 bar pressure resistant ceramic cartridge used
- G 1/2 M-1/2 25 bar pressure resistant steel braided flex used
- Box 12 pieces

LG - 003

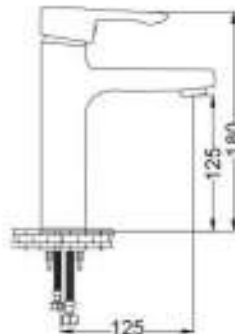

WASH BASIN FAUCET

- Water saving special aerator (foam flow, line breaker, flow rate: 8l / min)
- Ideal working pressure 3-4 Bar
- Our product is made of H556/H563 brass low pressure ingots
- Surface coating is 0.05 mm chrome coating
- 25 bar pressure resistant ceramic cartridge used
- G 1/2 M-1/2 25 bar pressure resistant steel braided flex used

L SHADOW SERIES

LS - 001

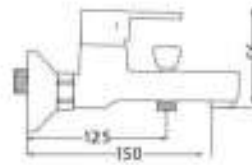

350
TS EN 917



BATHROOM FAUCET

- Our product is made of MS58/MS57 brass low pressure ingots
- Surface coating is 0.6 mm chrome coating
- 25 bar pressure resistant ceramic cartridge used
- Hand shower connections are G 3/8"
- Box 12 pieces

LS - 002

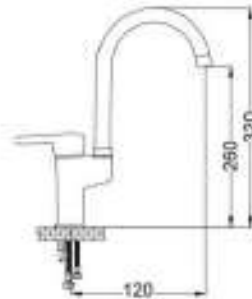

350
TS EN 917



KITCHEN FAUCET

- Water saving special aerator (foam flow, flow breaker, flow rate 8L/min)
- Ideal working pressure 3-4 Bar
- Our product is made of MS58/MS57 brass low pressure ingots
- Surface coating is 0.6 mm chrome coating
- 360 degree rotating tube
- 25 bar pressure resistant ceramic cartridge used
- G 3/8 H-05 25 bar pressure resistant steel braided flex used
- Box 12 pieces

LS - 003

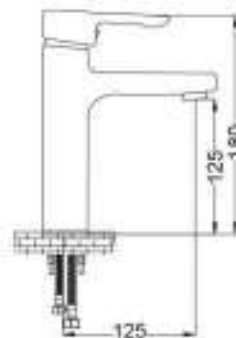

350
TS EN 917



WASH BASIN FAUCET

- Water saving special aerator (foam flow, flow breaker, flow rate 8L/min)
- Ideal working pressure 3-4 Bar
- Our product is made of MS58/MS57 brass low pressure ingots
- Surface coating is 0.6 mm chrome coating
- 25 bar pressure resistant ceramic cartridge used
- G 3/8 H-05 25 bar pressure resistant steel braided flex used

P SERIES

P - 001

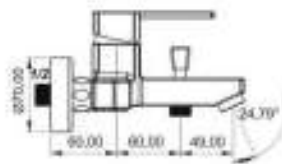

TS EN 817



BATHROOM FAUCET

- Our product is made of MS58/MS63 brass low pressure fittings
- Surface coating is 0.36 mm chrome coating
- 25 bar pressure resistant ceramic cartridge used
- Hand shower connections are G 3/8
- Box 12 pieces

P - 002



TS EN 817



KITCHEN FAUCET

- Water saving special aerator (foam flow, line breaker, flow rate: 8l / min)
- Ideal working pressure 3-4 Bar
- Our product is made of MS58/MS63 brass low pressure fittings
- Surface coating is 0.36 mm chrome coating
- 360 degree rotating tube
- 25 bar pressure resistant ceramic cartridge used
- G 3/8 M 10 25 bar pressure resistant steel braided flex used
- Box 12 pieces

P - 003

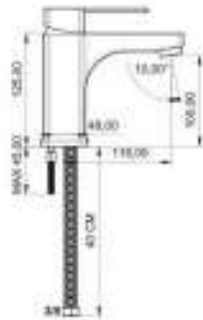

TS EN 817



BASIN FAUCET

- Water saving special aerator (foam flow, line breaker, flow rate: 8l / min)
- Ideal working pressure 3-4 Bar
- Our product is made of MS58/MS63 brass low pressure fittings
- Surface coating is 0.36 mm chrome coating
- 25 bar pressure resistant ceramic cartridge used
- G 3/8 M 10 25 bar pressure resistant steel braided flex used

S SERIES

S - 001



BATHROOM FAUCET

- Our product is made of MS58/MS53 brass low pressure ingots
- Surface coating is 0.15 mm chrome coating
- 25 bar pressure resistant ceramic cartridge used
- Hand shower connections are G 1/2"
- Box 12 pieces

350
TS EN 817

S - 002



KITCHEN FAUCET

- Water saving special aerator (flame flow, time breaker, flow rate: 8l / min)
- Ideal working pressure: 3-4 Bar
- Our product is made of MS58/MS53 brass low pressure ingots
- Surface coating is 0.15 mm chrome coating
- 360 degree rotating tube
- 25 bar pressure resistant ceramic cartridge used
- G 3/8" M-10 25 bar pressure resistant steel braided flex used
- Box 12 pieces

350
TS EN 817

S - 003

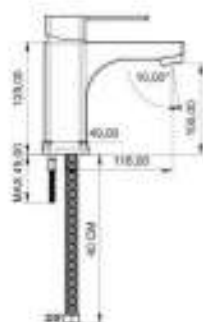

BASIN FAUCET

- Water saving special aerator (flame flow, time breaker, flow rate: 8l / min)
- Ideal working pressure: 3-4 Bar
- Our product is made of MS58/MS53 brass low pressure ingots
- Surface coating is 0.15 mm chrome coating
- 25 bar pressure resistant ceramic cartridge used
- G 3/8" M-10 25 bar pressure resistant steel braided flex used

350
TS EN 817

K SERIES

K - 001



BATHROOM FAUCET

- Our product is made of MS58/MS53 brass low pressure fittings
- Surface coating is 0.18 mm chrome coating
- 25 bar pressure resistant ceramic cartridge used
- Metal shower connections are G 1/2"
- Size 12 pieces

403
TS EN 817



K - 002



KITCHEN FAUCET

- Water saving special aerator (flam flow, line breaker, flow rate: 88 l/min)
- Ideal working pressure 2-4 Bar
- Our product is made of MS58/MS53 brass low pressure fittings
- Surface coating is 0.18 mm chrome coating
- 360 degree rotating tube
- 25 bar pressure resistant ceramic cartridge used
- G 3/8 H-10 25 bar pressure resistant steel braided flex used
- Size 12 pieces

403
TS EN 817



K - 003



WASH BASIN FAUCET

- Water saving special aerator (flam flow, line breaker, flow rate: 88 l/min)
- Ideal working pressure 3-4 Bar
- Our product is made of MS58/MS53 brass low pressure fittings
- Surface coating is 0.18 mm chrome coating
- 25 bar pressure resistant ceramic cartridge used
- G 3/8 H-10 25 bar pressure resistant steel braided flex used

403
TS EN 817



E SERIES

E - 001

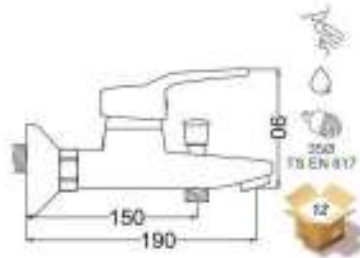

BATHROOM FAUCET

- Our product is made of MS58/MS53 brass low pressure ingots
- Surface coating is 0.15 mm chrome coating
- 25 bar pressure resistant ceramic cartridge used
- Hard shower connections are G 1/2"
- Box 12 pieces

E - 002



KITCHEN FAUCET

- Water saving special aerator (foam flow, line breaker, flow rate: 8l / min)
- Ideal working pressure: 3-4 bar
- Our product is made of MS58/MS53 brass low pressure ingots
- Surface coating is 0.15 mm chrome coating
- 360 degree rotating tube
- 25 bar pressure resistant ceramic cartridge used
- G 3/8" M10 25 bar pressure resistant steel braided flex used

E - 003



WASH BASIN FAUCET

- Water saving special aerator (foam flow, line breaker, flow rate: 8l / min)
- Ideal working pressure: 3-4 bar
- Our product is made of MS58/MS53 brass low pressure ingots
- Surface coating is 0.15 mm chrome coating
- 360 degree rotating tube
- 25 bar pressure resistant ceramic cartridge used
- G 3/8" M10 25 bar pressure resistant steel braided flex used

E - 004

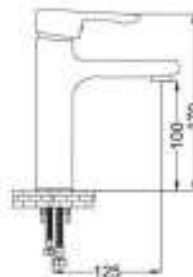

WASH BASIN FAUCET

- Water saving special aerator (foam flow, line breaker, flow rate: 8l / min)
- Ideal working pressure: 3-4 bar
- Our product is made of MS58/MS53 brass low pressure ingots
- Surface coating is 0.15 mm chrome coating
- 25 bar pressure resistant ceramic cartridge used
- G 3/8" M10 25 bar pressure resistant steel braided flex used
- G 3/8" M10 25 bar pressure resistant steel braided flex used

F SERIES

F - 001

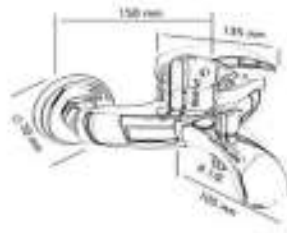

BATHROOM FAUCET

- Our product is made of MS20/MS23 brass low pressure rigids
- Surface coating is 0.30 mm chrome coating
- 25 bar pressure resistant ceramic cartridge used
- Hand shower connectors are G 1/2
- Box 12 pieces

400
TS EN 917



F - 002



KITCHEN FAUCET

- Water saving special aerator (foam flow, flow breaker, flow rate: 0.8 l / min)
- Ideal working pressure: 1-4 Bar
- Our product is made of MS20/MS23 brass low pressure rigids
- Surface coating is 0.30 mm chrome coating
- 350 degree rotating tube
- 25 bar pressure resistant ceramic cartridge used
- G 3/8 M-10 25 bar pressure resistant steel braided flex used
- Box 12 pieces

450
TS EN 917



F - 003

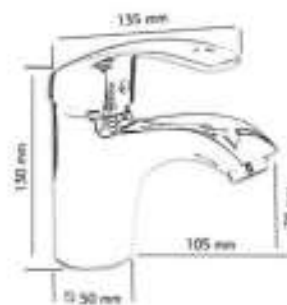

WASH BASIN FAUCET

- Water saving special aerator (foam flow, flow breaker, flow rate: 0.7 l / min)
- Ideal working pressure: 3-4 Bar
- Our product is made of MS20/MS23 brass low pressure rigids
- Surface coating is 0.30 mm chrome coating
- 25 bar pressure resistant ceramic cartridge used
- G 3/8 M-10 25 bar pressure resistant steel braided flex used
- G 3/8 M-10 25 bar pressure resistant steel braided flex used

400
TS EN 917



F SERIES

F - 004

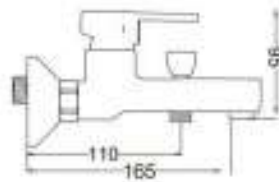

BATHROOM FAUCET

- Our product is made of MS58/MS63 brass low-pressure inputs
- Surface coating is 0,16 mm chrome coating
- 25 bar pressure resistant ceramic cartridge used
- Hot shower connections see G 1/2"

F - 005



KITCHEN FAUCET

- Water saving special aerator (foam flow, line breaker, flow rate: 8l / min)
- Ideal working pressure: 3-4 bar
- Our product is made of MS58/MS63 brass low-pressure inputs
- Surface coating is 0,16 mm chrome coating
- 90 degree rotating tube
- 25 bar pressure resistant ceramic cartridge used
- G 3/8 H 10 25 bar pressure resistant steel braided flex used

F - 006

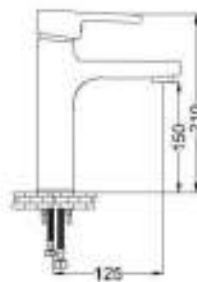

BASIN FAUCET

- Water saving special aerator (foam flow, line breaker, flow rate: 8l / min)
- Ideal working pressure: 3-4 bar
- Our product is made of MS58/MS63 brass low-pressure inputs
- Surface coating is 0,16 mm chrome coating
- 25 bar pressure resistant ceramic cartridge used
- G 3/8 H 10 25 bar pressure resistant steel braided flex used

F - 007

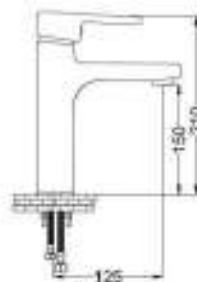

BASIN FAUCET

- Water saving special aerator (foam flow, line breaker, flow rate: 8l / min)
- Ideal working pressure: 3-4 bar
- Our product is made of MS58/MS63 brass low-pressure inputs
- Surface coating is 0,16 mm chrome coating
- 25 bar pressure resistant ceramic cartridge used
- G 3/8 H 10 25 bar pressure resistant steel braided flex used



M GOLD SERIES

MG - 001

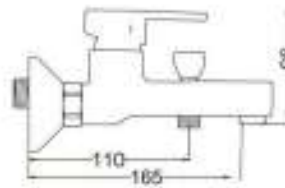

BATHROOM FAUCET

- Our product is made of M358/M353 brass low pressure ingots.
- Surface coating is 0.10 mm chrome coating.
- 25 bar pressure resistant ceramic cartridge used.
- Need shower connections are G 1/2.

MG - 002



KITCHEN FAUCET

- Water saving special aerator (foam flow line breaker, flow rate: 3l / min).
- Ideal working pressure 3-4 Bar.
- Our product is made of M358/M353 brass low pressure ingots.
- Surface coating is 0.10 mm chrome coating.
- 360 degree rotating tube.
- 25 bar pressure resistant ceramic cartridge used.
- G 3/8 M 10 25 bar pressure resistant steel braided flex used.
- Box 12 pieces.

MG - 003

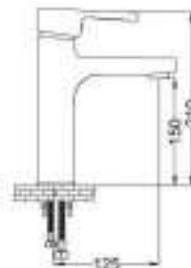

BASIN FAUCET

- Water saving special aerator (foam flow line breaker, flow rate: 3l / min).
- Ideal working pressure 3-4 Bar.
- Our product is made of M358/M353 brass low pressure ingots.
- Surface coating is 0.10 mm chrome coating.
- 25 bar pressure resistant ceramic cartridge used.
- G 3/8 M 10 25 bar pressure resistant steel braided flex used.

M ROSE SERIES

MR - 001

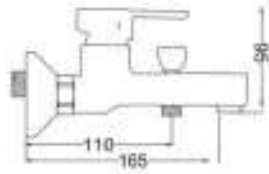

BATHROOM FAUCET

- Our product is made of H558/H553 brass low pressure alloys
- Surface coating is 0.36 mm chrome coating
- 25 bar pressure resistant ceramic cartridge used
- Hand shower connectors are G 3/8"

350
TS EN 817



MR - 002



KITCHEN FAUCET

- Water saving special sensor (foam flow, time breaker, flow rate: 8lt / min)
- Ideal working pressure 3-4 Bar
- Our product is made of H558/H553 brass low pressure alloys
- Surface coating is 0.36 mm chrome coating
- 360 degree rotating tube
- 25 bar pressure resistant ceramic cartridge used
- G 3/8 H40 25 bar pressure resistant steel braided flex used
- Box 12 pieces

350
TS EN 817



MR - 003



BASIN FAUCET

- Water saving special sensor (foam flow, time breaker, flow rate: 8lt / min)
- Ideal working pressure 3-4 Bar
- Our product is made of H558/H553 brass low pressure alloys
- Surface coating is 0.36 mm chrome coating
- 25 bar pressure resistant ceramic cartridge used
- G 3/8 H40 25 bar pressure resistant steel braided flex used

350
TS EN 817



H SERIES

H - 001

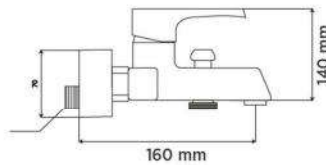

BATHROOM FAUCET

- Our product is made of MS58/MS53 brass low pressure ingots
- Surface coating is 0.16 mm chrome coating
- 25 bar pressure resistant ceramic cartridge used
- Hand shower connections are G ½
- Box 12 pieces

350
TS EN 817



H - 002

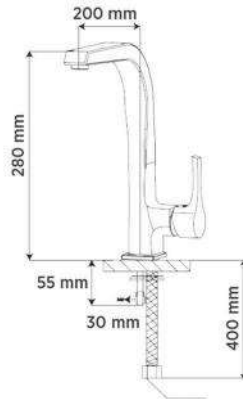

KITCHEN FAUCET

- Water saving special aerator (foam flow, lime breaker, flow rate: 8lt / min)
- Ideal working pressure 3-4 Bar
- Our product is made of MS58/MS63 brass low pressure ingots
- Surface coating is 0.16 mm chrome coating
- 360 degree rotating tube
- 25 bar pressure resistant ceramic cartridge used
- G 3/8 M-10 25 bar pressure resistant steel braided flex used

350
TS EN 817



H - 003

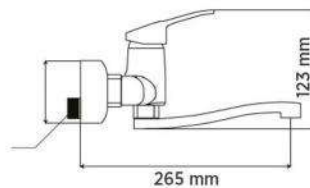

KITCHEN FAUCET

- Water saving special aerator (foam flow, lime breaker, flow rate: 8lt / min)
- Ideal working pressure 3-4 Bar
- Our product is made of MS58/MS63 brass low pressure ingots
- Surface coating is 0.16 mm chrome coating
- 360 degree rotating tube
- 25 bar pressure resistant ceramic cartridge used
- G 3/8 M-10 25 bar pressure resistant steel braided flex used

350
TS EN 817



H - 004

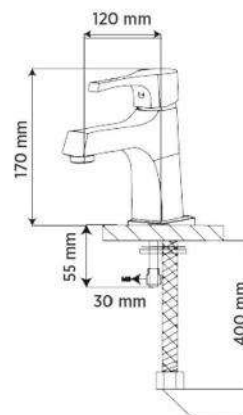

WASH BASIN FAUCET

- Water saving special aerator (foam flow, lime breaker, flow rate: 8lt / min)
- Ideal working pressure 3-4 Bar
- Our product is made of MS58/MS63 brass low pressure ingots
- Surface coating is 0.16 mm chrome coating
- 25 bar pressure resistant ceramic cartridge used
- G 3/8 M-10 25 bar pressure resistant steel braided flex used
- G 3/8 M-10 25 bar pressure resistant steel braided flex used

350
TS EN 817



EF SERIES

EF - 001

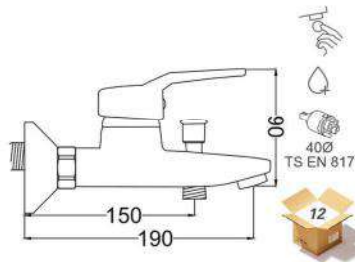

BATHROOM FAUCET

- Our product is made of MS58/MS53 brass low pressure ingots
- Surface coating is 0.16 mm chrome coating
- 25 bar pressure resistant ceramic cartridge used
- Hand shower connections are G 1/2"
- Box 12 pieces

EF - 002

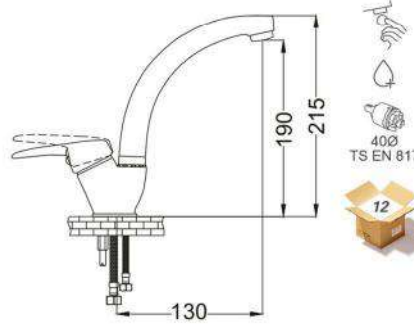

KITCHEN FAUCET

- Water saving special aerator (foam flow, lime breaker, flow rate: 8lt / min)
- Ideal working pressure 3-4 Bar
- Our product is made of MS58/MS63 brass low pressure ingots
- Surface coating is 0.16 mm chrome coating
- 360 degree rotating tube
- 25 bar pressure resistant ceramic cartridge used
- G 3/8 M-10 25 bar pressure resistant steel braided flex used

EF - 003

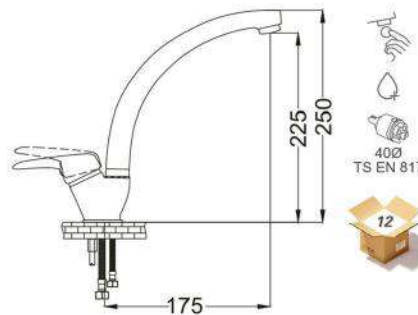

WASH BASIN FAUCET

- Water saving special aerator (foam flow, lime breaker, flow rate: 8lt / min)
- Ideal working pressure 3-4 Bar
- Our product is made of MS58/MS63 brass low pressure ingots
- Surface coating is 0.16 mm chrome coating
- 25 bar pressure resistant ceramic cartridge used
- G 3/8 M-10 25 bar pressure resistant steel braided flex used
- G 3/8 M-10 25 bar pressure resistant steel braided flex used

EF - 004

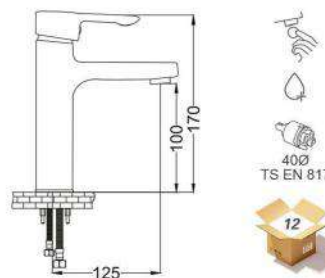

WASH BASIN FAUCET

- Water saving special aerator (foam flow, lime breaker, flow rate: 8lt / min)
- Ideal working pressure 3-4 Bar
- Our product is made of MS58/MS63 brass low pressure ingots
- Surface coating is 0.16 mm chrome coating
- 25 bar pressure resistant ceramic cartridge used
- G 3/8 M-10 25 bar pressure resistant steel braided flex used
- G 3/8 M-10 25 bar pressure resistant steel braided flex used

A SERIES

A - 001

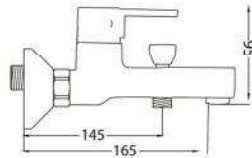

BATHROOM FAUCET

- Our product is made of MS58/MS55 brass low pressure ingots
- Surface coating is 0.16 mm chrome coating
- 25 bar pressure resistant ceramic cartridge used
- Hand shower connections are G ½
- Box 12 pieces



A - 002

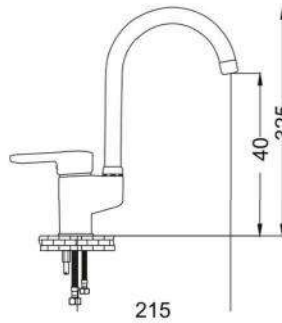

KITCHEN FAUCET

- Water saving special aerator (foam flow, lime breaker, flow rate: 8lt / min)
- Ideal working pressure 3-4 Bar
- Our product is made of MS58/MS63 brass low pressure ingots
- Surface coating is 0.16 mm chrome coating
- 360 degree rotating tube
- 25 bar pressure resistant ceramic cartridge used
- G 3/8 M-10 25 bar pressure resistant steel braided flex used
- Box 12 pieces



A - 003

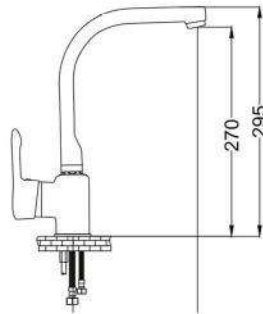

KITCHEN FAUCET

- Water saving special aerator (foam flow, lime breaker, flow rate: 8lt / min)
- Ideal working pressure 3-4 Bar
- Our product is made of MS58/MS63 brass low pressure ingots
- Surface coating is 0.16 mm chrome coating
- 360 degree rotating tube
- 25 bar pressure resistant ceramic cartridge used
- G 3/8 M-10 25 bar pressure resistant steel braided flex used
- Box 12 pieces



A SERIES

A - 004

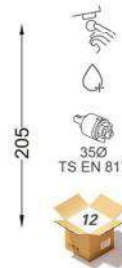
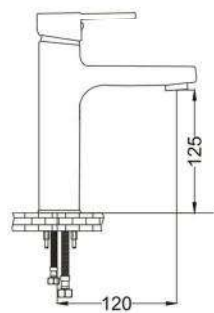

WASH BASIN FAUCET

- Water saving special aerator (foam flow, lime breaker, flow rate: 8lt / min)
- Ideal working pressure 3-4 Bar
- Our product is made of MS58/MS63 brass low pressure ingots
- Surface coating is 0.16 mm chrome coating
- 25 bar pressure resistant ceramic cartridge used
- G 3/8 M-10 25 bar pressure resistant steel braided flex used

A - 005

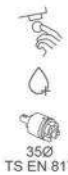

BASIN FAUCET

- Water saving special aerator (foam flow, lime breaker, flow rate: 8lt / min)
- Ideal working pressure 3-4 Bar
- Our product is made of MS58/MS63 brass low pressure ingots
- Surface coating is 0.16 mm chrome coating
- 25 bar pressure resistant ceramic cartridge used
- G 3/8 M-10 25 bar pressure resistant steel braided flex used

KR SERIES

KR - 001



BATHROOM FAUCET

- Our product is made of MS58/MS53 brass low pressure ingots
- Surface coating is 0.16 mm chrome coating
- 25 bar pressure resistant ceramic cartridge used
- Hand shower connections are G 1/2
- Box 12 pieces



KR - 002



KITCHEN FAUCET

- Water saving special aerator (foam flow, lime breaker, flow rate: 8lt / min)
- Ideal working pressure 3-4 Bar
- Our product is made of MS58/MS63 brass low pressure ingots
- Surface coating is 0.16 mm chrome coating
- 25 bar pressure resistant ceramic cartridge used
- G 3/8 M-10 25 bar pressure resistant steel braided flex used
- Box 12 pieces



KR - 003



WASH BASIN FAUCET

- Water saving special aerator (foam flow, lime breaker, flow rate: 8lt / min)
- Ideal working pressure 3-4 Bar
- Our product is made of MS58/MS63 brass low pressure ingots
- Surface coating is 0.16 mm chrome coating
- 25 bar pressure resistant ceramic cartridge used
- G 3/8 M-10 25 bar pressure resistant steel braided flex used
- G 3/8 M-10 25 bar pressure resistant steel braided flex used



KR SERIES

KR - 004



KITCHEN FAUCET

- Water saving special aerator (foam flow, lime breaker, flow rate: 8lt / min)
- Ideal working pressure 3-4 Bar
- Our product is made of MS58/MS63 brass low pressure ingots
- Surface coating is 0.16 mm chrome coating
- 360 degree rotating tube
- 25 bar pressure resistant ceramic cartridge used
- G 3/8 M-10 25 bar pressure resistant steel braided flex used



KR - 005

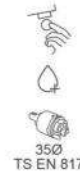

WASH BASIN FAUCET

- Water saving special aerator (foam flow, lime breaker, flow rate: 8lt / min)
- Ideal working pressure 3-4 Bar
- Our product is made of MS58/MS63 brass low pressure ingots
- Surface coating is 0.16 mm chrome coating
- 25 bar pressure resistant ceramic cartridge used
- G 3/8 M-10 25 bar pressure resistant steel braided flex used
- G 3/8 M-10 25 bar pressure resistant steel braided flex used



KR - 006



KR - 007



SHUT-OFF FAUCET

- Water saving special aerator (foam flow, lime breaker, flow rate: 8lt / min)
- Ideal working pressure 3-4 Bar
- Our product is made of MS58/MS63 brass low pressure ingots
- Surface coating is 0.16 mm chrome coating
- 25 bar pressure resistant ceramic cartridge used
- G 3/8 M-10 25 bar pressure resistant steel braided flex used
- Box 12 pieces



AVS SERIES

AVS - 001

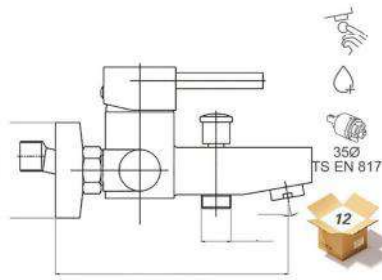

BATHROOM FAUCET

- Our product is made of MS58/MS53 brass low pressure ingots
- Surface coating is 0.16 mm chrome coating
- 25 bar pressure resistant ceramic cartridge used
- Hand shower connections are G ½
- Box 12 pieces

AVS - 002

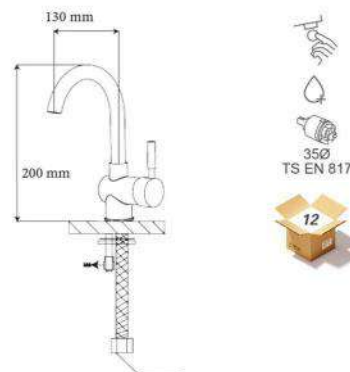

KITCHEN FAUCET

- Our product is made of MS58/MS53 brass low pressure ingots
- Surface coating is 0.16 mm chrome coating
- 25 bar pressure resistant ceramic cartridge used
- Hand shower connections are G ½
- Box 12 pieces

AVS - 003

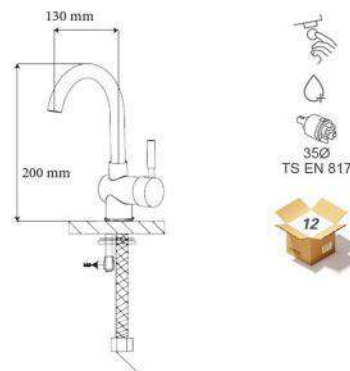

WASH BASIN FAUCET

- Our product is made of MS58/MS53 brass low pressure ingots
- Surface coating is 0.16 mm chrome coating
- 25 bar pressure resistant ceramic cartridge used
- Hand shower connections are G ½
- Box 12 pieces

AVS SERIES

AVS - 004

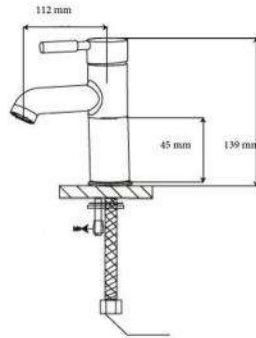

WASH BASIN FAUCET

- Water saving special aerator (foam flow, lime breaker, flow rate: 8lt / min)
- Ideal working pressure 3-4 Bar
- Our product is made of MS58/MS63 brass low pressure ingots
- Surface coating is 0.16 mm chrome coating
- 25 bar pressure resistant ceramic cartridge used
- G 3/8 M-10 25 bar pressure resistant steel braided flex used
- G 3/8 M-10 25 bar pressure resistant steel braided flex used



AVS - 005

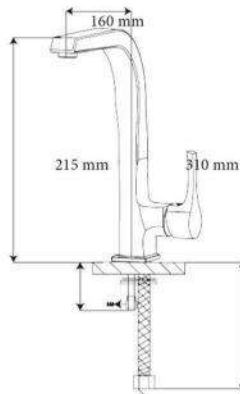

WASH BASIN FAUCET

- Water saving special aerator (foam flow, lime breaker, flow rate: 8lt / min)
- Ideal working pressure 3-4 Bar
- Our product is made of MS58/MS63 brass low pressure ingots
- Surface coating is 0.16 mm chrome coating
- 25 bar pressure resistant ceramic cartridge used
- G 3/8 M-10 25 bar pressure resistant steel braided flex used
- G 3/8 M-10 25 bar pressure resistant steel braided flex used



AVS - 006

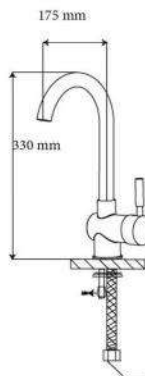

KITCHEN FAUCET

- Water saving special aerator (foam flow, lime breaker, flow rate: 8lt / min)
- Ideal working pressure 3-4 Bar
- Our product is made of MS58/MS63 brass low pressure ingots
- Surface coating is 0.16 mm chrome coating
- 360 degree rotating tube
- 25 bar pressure resistant ceramic cartridge used
- G 3/8 M-10 25 bar pressure resistant steel braided flex used
- Box 12 pieces



LR SERIES

LR - 001

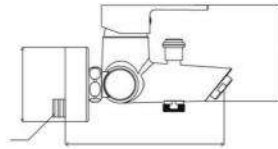

BATHROOM FAUCET

- Our product is made of MS58/MS63 brass low pressure ingots
- Surface coating is 0.16 mm chrome coating
- 25 bar pressure resistant ceramic cartridge used
- Hand shower connections are G 3/8"
- Box 12 pieces



LR - 002

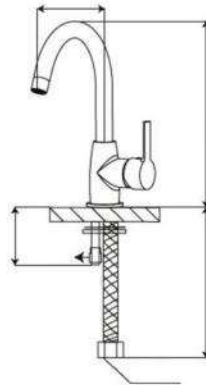

KITCHEN FAUCET

- Water saving special aerator (foam flow, lime breaker, flow rate: 8lt / min)
- Ideal working pressure 3-4 Bar
- Our product is made of MS58/MS63 brass low pressure ingots
- Surface coating is 0.16 mm chrome coating
- 360 degree rotating tube
- 25 bar pressure resistant ceramic cartridge used
- G 3/8" M-10 25 bar pressure resistant steel braided flex used.



LR - 003

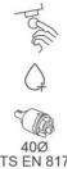
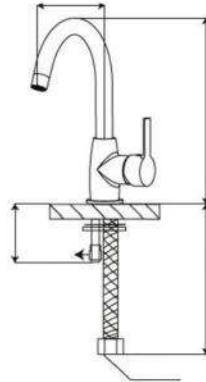

WASH BASIN FAUCET

- Water saving special aerator (foam flow, lime breaker, flow rate: 8lt / min)
- Ideal working pressure 3-4 Bar
- Our product is made of MS58/MS63 brass low pressure ingots
- Surface coating is 0.16 mm chrome coating
- 25 bar pressure resistant ceramic cartridge used
- G 3/8" M-10 25 bar pressure resistant steel braided flex used
- G 3/8" M-10 25 bar pressure resistant steel braided flex used.



LR - 004

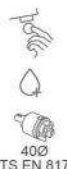
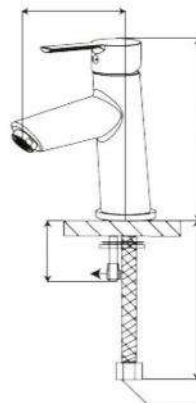

WASH BASIN FAUCET

- Water saving special aerator (foam flow, lime breaker, flow rate: 8lt / min)
- Ideal working pressure 3-4 Bar
- Our product is made of MS58/MS63 brass low pressure ingots
- Surface coating is 0.16 mm chrome coating
- 360 degree rotating tube
- 25 bar pressure resistant ceramic cartridge used
- G 3/8" M-10 25 bar pressure resistant steel braided flex used
- Box 12 pieces



LR SERIES

LR - 005

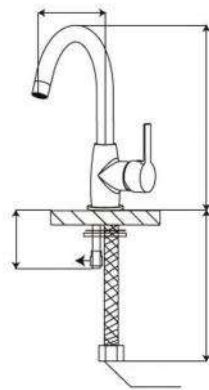

KITCHEN FAUCET

- Water saving special aerator (foam flow, lime breaker, flow rate: 8lt / min)
- Ideal working pressure 3-4 Bar
- Our product is made of MS58/MS63 brass low pressure ingots
- Surface coating is 0.16 mm chrome coating
- 360 degree rotating tube
- 25 bar pressure resistant ceramic cartridge used
- G 3/8 M-10 25 bar pressure resistant steel braided flex used



LR - 006

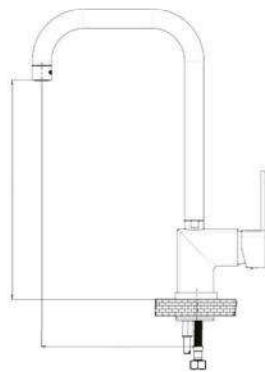

KITCHEN FAUCET

- Water saving special aerator (foam flow, lime breaker, flow rate: 8lt / min)
- Ideal working pressure 3-4 Bar
- Our product is made of MS58/MS63 brass low pressure ingots
- Surface coating is 0.16 mm chrome coating
- 360 degree rotating tube
- 25 bar pressure resistant ceramic cartridge used
- G 3/8 M-10 25 bar pressure resistant steel braided flex used



LR - 007



KITCHEN FAUCET

- Water saving special aerator (foam flow, lime breaker, flow rate: 8lt / min)
- Ideal working pressure 3-4 Bar
- Our product is made of MS58/MS63 brass low pressure ingots
- Surface coating is 0.16 mm chrome coating
- 360 degree rotating tube
- 25 bar pressure resistant ceramic cartridge used
- G 3/8 M-10 25 bar pressure resistant steel braided flex used



LR - 008

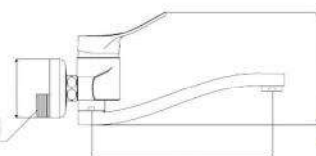

KITCHEN FAUCET

- Water saving special aerator (foam flow, lime breaker, flow rate: 8lt / min)
- Ideal working pressure 3-4 Bar
- Our product is made of MS58/MS63 brass low pressure ingots
- Surface coating is 0.16 mm chrome coating
- 360 degree rotating tube
- 25 bar pressure resistant ceramic cartridge used
- G 3/8 M-10 25 bar pressure resistant steel braided flex used



LR SERIES

LR - 009

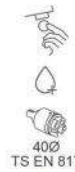
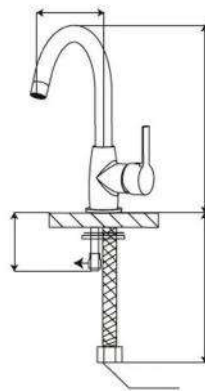

KITCHEN FAUCET

- Water saving special aerator (foam flow, lime breaker, flow rate: 8lt / min)
- Ideal working pressure 3-4 Bar
- Our product is made of MS58/MS63 brass low pressure ingots
- Surface coating is 0.16 mm chrome coating
- 25 bar pressure resistant ceramic cartridge used
- G 3/8 M-10 25 bar pressure resistant steel braided flex used
- G 3/8 M-10 25 bar pressure resistant steel braided flex used



LR - 010

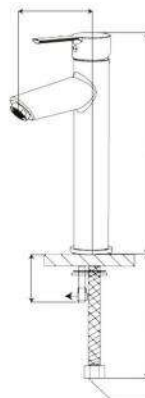

WASH BASIN FAUCET

- Water saving special aerator (foam flow, lime breaker, flow rate: 8lt / min)
- Ideal working pressure 3-4 Bar
- Our product is made of MS58/MS63 brass low pressure ingots
- Surface coating is 0.16 mm chrome coating
- 360 degree rotating tube
- 25 bar pressure resistant ceramic cartridge used
- G 3/8 M-10 25 bar pressure resistant steel braided flex used
- Box 12 pieces



LR GOLD SERIES

LRG - 001

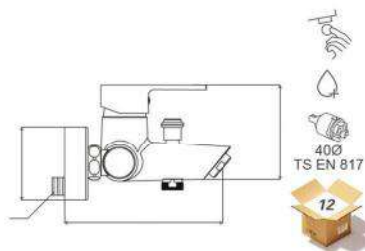

BATHROOM FAUCET

- Our product is made of MS58/MS53 brass low pressure ingots
- Surface coating is 0.16 mm chrome coating
- 25 bar pressure resistant ceramic cartridge used
- Hand shower connections are G 1/2
- Box 12 pieces

LRG - 002

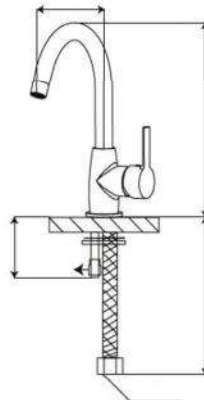

KITCHEN FAUCET

- Water saving special aerator (foam flow, lime breaker, flow rate: 8lt / min)
- Ideal working pressure 3-4 Bar
- Our product is made of MS58/MS63 brass low pressure ingots
- Surface coating is 0.16 mm chrome coating
- 360 degree rotating tube
- 25 bar pressure resistant ceramic cartridge used
- G 3/8 M-10 25 bar pressure resistant steel braided flex used

LRG - 003

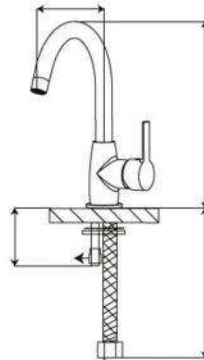

WASH BASIN FAUCET

- Water saving special aerator (foam flow, lime breaker, flow rate: 8lt / min)
- Ideal working pressure 3-4 Bar
- Our product is made of MS58/MS63 brass low pressure ingots
- Surface coating is 0.16 mm chrome coating
- 25 bar pressure resistant ceramic cartridge used
- G 3/8 M-10 25 bar pressure resistant steel braided flex used
- G 3/8 M-10 25 bar pressure resistant steel braided flex used

LRG - 004

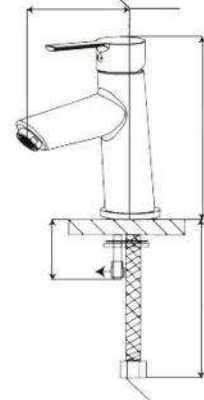

WASH BASIN FAUCET

- Water saving special aerator (foam flow, lime breaker, flow rate: 8lt / min)
- Ideal working pressure 3-4 Bar
- Our product is made of MS58/MS63 brass low pressure ingots
- Surface coating is 0.16 mm chrome coating
- 25 bar pressure resistant ceramic cartridge used
- G 3/8 M-10 25 bar pressure resistant steel braided flex used
- G 3/8 M-10 25 bar pressure resistant steel braided flex used

LR WHITE SERIES

LRW - 001

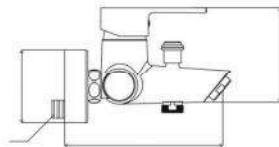

BATHROOM FAUCET

- Our product is made of MS58/MS53 brass low pressure ingots
- Surface coating is 0.16 mm chrome coating
- 25 bar pressure resistant ceramic cartridge used
- Hand shower connections are G ½
- Box 12 pieces

LRW - 002

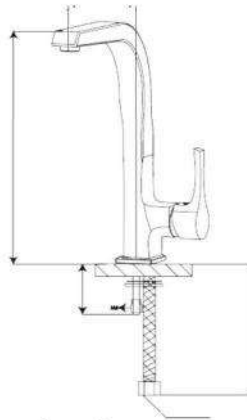

KITCHEN FAUCET

- Water saving special aerator (foam flow, lime breaker, flow rate: 8lt / min)
- Ideal working pressure 3-4 Bar
- Our product is made of MS58/MS63 brass low pressure ingots
- Surface coating is 0.16 mm chrome coating
- 360 degree rotating tube
- 25 bar pressure resistant ceramic cartridge used
- G 3/8 M-10 25 bar pressure resistant steel braided flex used

LRW - 003

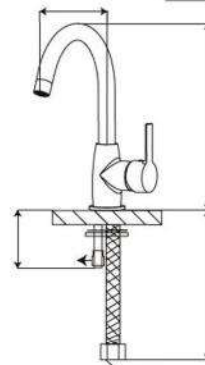

WASH BASIN FAUCET

- Water saving special aerator (foam flow, lime breaker, flow rate: 8lt / min)
- Ideal working pressure 3-4 Bar
- Our product is made of MS58/MS63 brass low pressure ingots
- Surface coating is 0.16 mm chrome coating
- 25 bar pressure resistant ceramic cartridge used
- G 3/8 M-10 25 bar pressure resistant steel braided flex used
- G 3/8 M-10 25 bar pressure resistant steel braided flex used

LRW - 004

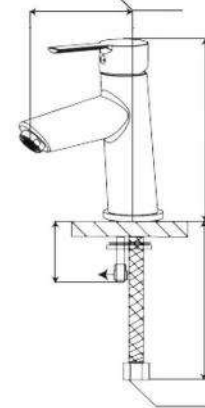

WASH BASIN FAUCET

- Water saving special aerator (foam flow, lime breaker, flow rate: 8lt / min)
- Ideal working pressure 3-4 Bar
- Our product is made of MS58/MS63 brass low pressure ingots
- Surface coating is 0.16 mm chrome coating
- 25 bar pressure resistant ceramic cartridge used
- G 3/8 M-10 25 bar pressure resistant steel braided flex used
- G 3/8 M-10 25 bar pressure resistant steel braided flex used

LR SHADOW SERIES

LRS - 001

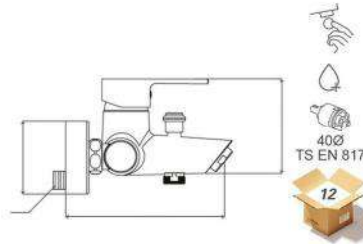

BATHROOM FAUCET

- Our product is made of MS58/MS53 brass low pressure ingots
- Surface coating is 0.16 mm chrome coating
- 25 bar pressure resistant ceramic cartridge used
- Hand shower connections are G 1/2"
- Box 12 pieces

LRS - 002

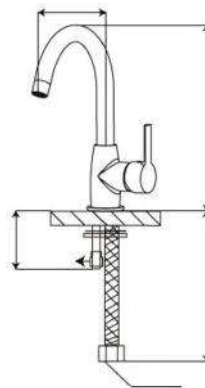

KITCHEN FAUCET

- Water saving special aerator (foam flow, lime breaker, flow rate: 8lt / min)
- Ideal working pressure 3-4 Bar
- Our product is made of MS58/MS63 brass low pressure ingots
- Surface coating is 0.16 mm chrome coating
- 360 degree rotating tube
- 25 bar pressure resistant ceramic cartridge used
- G 3/8 M-10 25 bar pressure resistant steel braided flex used

LRS - 003

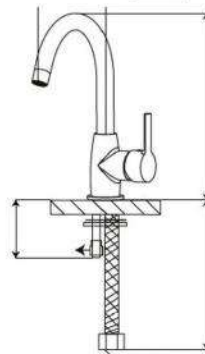

WASH BASIN FAUCET

- Water saving special aerator (foam flow, lime breaker, flow rate: 8lt / min)
- Ideal working pressure 3-4 Bar
- Our product is made of MS58/MS63 brass low pressure ingots
- Surface coating is 0.16 mm chrome coating
- 25 bar pressure resistant ceramic cartridge used
- G 3/8 M-10 25 bar pressure resistant steel braided flex used
- G 3/8 M-10 25 bar pressure resistant steel braided flex used

LRS - 004

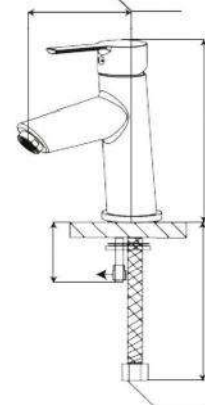

WASH BASIN FAUCET

- Water saving special aerator (foam flow, lime breaker, flow rate: 8lt / min)
- Ideal working pressure 3-4 Bar
- Our product is made of MS58/MS63 brass low pressure ingots
- Surface coating is 0.16 mm chrome coating
- 25 bar pressure resistant ceramic cartridge used
- G 3/8 M-10 25 bar pressure resistant steel braided flex used
- G 3/8 M-10 25 bar pressure resistant steel braided flex used

U SERIES

U - 001

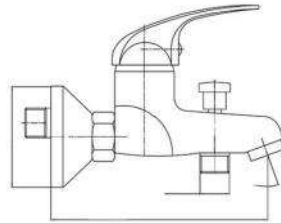

155 mm



400
TS EN 817



BATHROOM FAUCET

- Our product is made of MS58/MS53 brass low pressure ingots
- Surface coating is 0.16 mm chrome coating
- 25 bar pressure resistant ceramic cartridge used
- Hand shower connections are G ½
- Box 12 pieces

U - 002



400
TS EN 817



KITCHEN FAUCET

- Our product is made of MS58/MS53 brass low pressure ingots
- Surface coating is 0.16 mm chrome coating
- 25 bar pressure resistant ceramic cartridge used
- Hand shower connections are G ½
- Box 12 pieces

U - 003

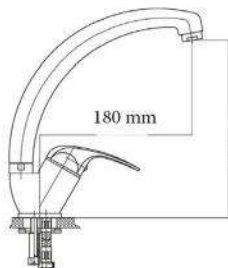

180 mm

170 mm

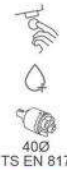

400
TS EN 817



WASH BASIN FAUCET

- Water saving special aerator (foam flow, lime breaker, flow rate:8lt / min)
- Ideal working pressure 3-4 Bar
- Our product is made of MS58/MS63 brass low pressure ingots
- Surface coating is 0.16 mm chrome coating
- 25 bar pressure resistant ceramic cartridge used
- G 3/8 M-10 25 bar pressure resistant steel braided flex used
- G 3/8 M-10 25 bar pressure resistant steel braided flex used

U - 004

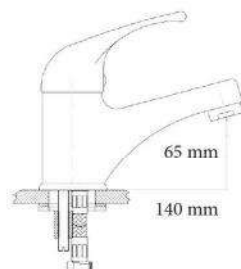

65 mm

140 mm



400
TS EN 817



WASH BASIN FAUCET

- Water saving special aerator (foam flow, lime breaker, flow rate:8lt / min)
- Ideal working pressure 3-4 Bar
- Our product is made of MS58/MS63 brass low pressure ingots
- Surface coating is 0.16 mm chrome coating
- 25 bar pressure resistant ceramic cartridge used
- G 3/8 M-10 25 bar pressure resistant steel braided flex used
- G 3/8 M-10 25 bar pressure resistant steel braided flex used

U SERIES

U - 005

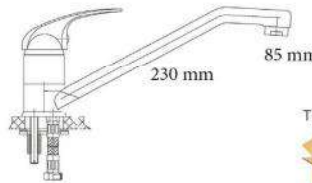

KITCHEN FAUCET

- Water saving special aerator (foam flow, lime breaker, flow rate: 8lt / min)
- Ideal working pressure 3-4 Bar
- Our product is made of MS58/MS63 brass low pressure ingots
- Surface coating is 0.16 mm chrome coating
- 360 degree rotating tube
- 25 bar pressure resistant ceramic cartridge used
- G 3/8 M-10 25 bar pressure resistant steel braided flex used

U - 006

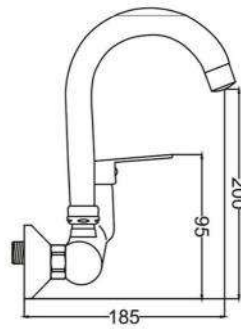

KITCHEN FAUCET

- Water saving special aerator (foam flow, lime breaker, flow rate: 8lt / min)
- Ideal working pressure 3-4 Bar
- Our product is made of MS58/MS63 brass low pressure ingots
- Surface coating is 0.16 mm chrome coating
- 360 degree rotating tube
- 25 bar pressure resistant ceramic cartridge used
- G 3/8 M-10 25 bar pressure resistant steel braided flex used

U - 007

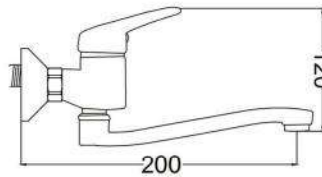

KITCHEN FAUCET

- Water saving special aerator (foam flow, lime breaker, flow rate: 8lt / min)
- Ideal working pressure 3-4 Bar
- Our product is made of MS58/MS63 brass low pressure ingots
- Surface coating is 0.16 mm chrome coating
- 360 degree rotating tube
- 25 bar pressure resistant ceramic cartridge used
- G 3/8 M-10 25 bar pressure resistant steel braided flex used

U - 008



KITCHEN FAUCET

- Water saving special aerator (foam flow, lime breaker, flow rate: 8lt / min)
- Ideal working pressure 3-4 Bar
- Our product is made of MS58/MS63 brass low pressure ingots
- Surface coating is 0.16 mm chrome coating
- 360 degree rotating tube
- 25 bar pressure resistant ceramic cartridge used
- G 3/8 M-10 25 bar pressure resistant steel braided flex used

U SERIES

U - 009

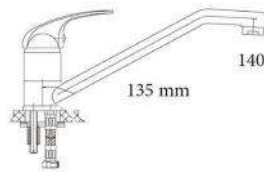

WASH BASIN FAUCET

- Water saving special aerator (foam flow, lime breaker, flow rate:8lt / min)
- Ideal working pressure 3-4 Bar
- Our product is made of M558/MS63 brass low pressure ingots
- Surface coating is 0.16 mm chrome coating
- 25 bar pressure resistant ceramic cartridge used
- G 3/8 M-10 25 bar pressure resistant steel braided flex used
- G 3/8 M-10 25 bar pressure resistant steel braided flex used

U - 010

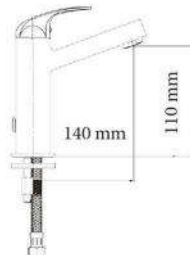

WASH BASIN FAUCET

- Water saving special aerator (foam flow, lime breaker, flow rate:8lt / min)
- Ideal working pressure 3-4 Bar
- Our product is made of M558/MS63 brass low pressure ingots
- Surface coating is 0.16 mm chrome coating
- 25 bar pressure resistant ceramic cartridge used
- G 3/8 M-10 25 bar pressure resistant steel braided flex used
- G 3/8 M-10 25 bar pressure resistant steel braided flex used

U - 011

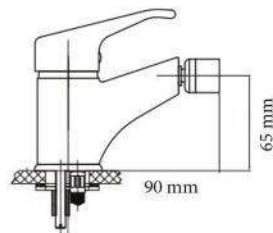

BIDE FAUCET

- Water saving special aerator (foam flow, lime breaker, flow rate:8lt / min)
- Ideal working pressure 3-4 Bar
- Our product is made of M558/MS63 brass low pressure ingots
- Surface coating is 0.16 mm chrome coating
- 25 bar pressure resistant ceramic cartridge used
- G 3/8 M-10 25 bar pressure resistant steel braided flex used
- G 3/8 M-10 25 bar pressure resistant steel braided flex used

V SERIES

V - 001

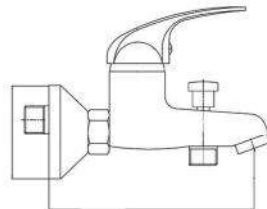

155 mm



BATHROOM FAUCET

- Our product is made of MS58/MS53 brass low pressure ingots
- Surface coating is 0.16 mm chrome coating
- 25 bar pressure resistant ceramic cartridge used
- Hand shower connections are G 1/2
- Box 12 pieces

V - 002

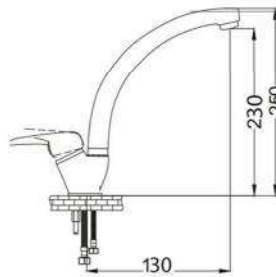

KITCHEN FAUCET

- Our product is made of MS58/MS53 brass low pressure ingots
- Surface coating is 0.16 mm chrome coating
- 25 bar pressure resistant ceramic cartridge used
- Hand shower connections are G 1/2
- Box 12 pieces

V - 003

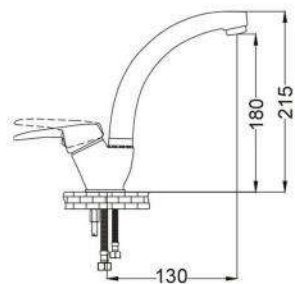

WASH BASIN FAUCET

- Water saving special aerator (foam flow, lime breaker, flow rate:8lt / min)
- Ideal working pressure 3-4 Bar
- Our product is made of MS58/MS63 brass low pressure ingots
- Surface coating is 0.16 mm chrome coating
- 25 bar pressure resistant ceramic cartridge used
- G 3/8 M-10 25 bar pressure resistant steel braided flex used
- G 3/8 M-10 25 bar pressure resistant steel braided flex used

V - 004

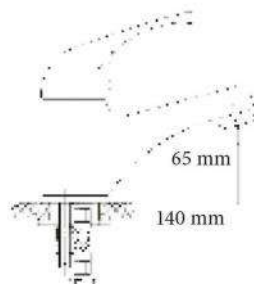

WASH BASIN FAUCET

- Water saving special aerator (foam flow, lime breaker, flow rate:8lt / min)
- Ideal working pressure 3-4 Bar
- Our product is made of MS58/MS63 brass low pressure ingots
- Surface coating is 0.16 mm chrome coating
- 25 bar pressure resistant ceramic cartridge used
- G 3/8 M-10 25 bar pressure resistant steel braided flex used
- G 3/8 M-10 25 bar pressure resistant steel braided flex used

V SERIES

V - 005

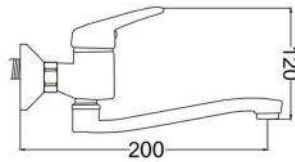

KITCHEN FAUCET

- Water saving special aerator (foam flow, lime breaker, flow rate: 8lt / min)
- Ideal working pressure 3-4 Bar
- Our product is made of MS58/MS63 brass low pressure ingots
- Surface coating is 0.16 mm chrome coating
- 360 degree rotating tube
- 25 bar pressure resistant ceramic cartridge used
- G 3/8 M-10 25 bar pressure resistant steel braided flex used



V - 006

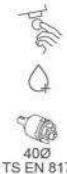
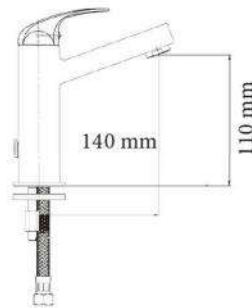

WASH BASIN FAUCET

- Water saving special aerator (foam flow, lime breaker, flow rate: 8lt / min)
- Ideal working pressure 3-4 Bar
- Our product is made of MS58/MS63 brass low pressure ingots
- Surface coating is 0.16 mm chrome coating
- 25 bar pressure resistant ceramic cartridge used
- G 3/8 M-10 25 bar pressure resistant steel braided flex used
- G 3/8 M-10 25 bar pressure resistant steel braided flex used



D SERIES

D - 001

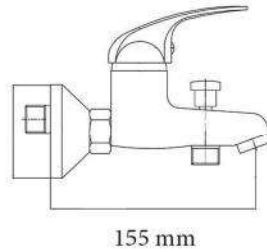

BATHROOM FAUCET

- Our product is made of MS58/MS53 brass low pressure ingots
- Surface coating is 0.16 mm chrome coating
- 25 bar pressure resistant ceramic cartridge used
- Hand shower connections are G ½
- Box 12 pieces

D - 002

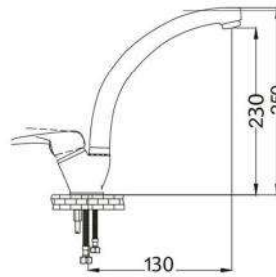

KITCHEN FAUCET

- Our product is made of MS58/MS53 brass low pressure ingots
- Surface coating is 0.16 mm chrome coating
- 25 bar pressure resistant ceramic cartridge used
- Hand shower connections are G ½
- Box 12 pieces

D - 003

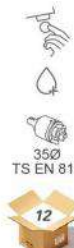
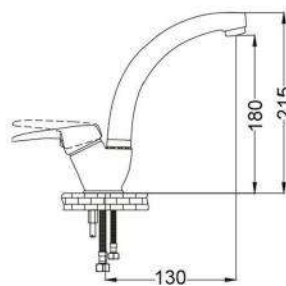

WASH BASIN FAUCET

- Water saving special aerator (foam flow, lime breaker, flow rate: 8lt / min)
- Ideal working pressure 3-4 Bar
- Our product is made of MS58/MS63 brass low pressure ingots
- Surface coating is 0.16 mm chrome coating
- 25 bar pressure resistant ceramic cartridge used
- G 3/8 M-10 25 bar pressure resistant steel braided flex used
- G 3/8 M-10 25 bar pressure resistant steel braided flex used

D - 004

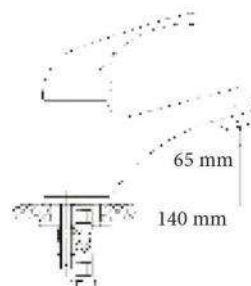

WASH BASIN FAUCET

- Water saving special aerator (foam flow, lime breaker, flow rate: 8lt / min)
- Ideal working pressure 3-4 Bar
- Our product is made of MS58/MS63 brass low pressure ingots
- Surface coating is 0.16 mm chrome coating
- 25 bar pressure resistant ceramic cartridge used
- G 3/8 M-10 25 bar pressure resistant steel braided flex used
- G 3/8 M-10 25 bar pressure resistant steel braided flex used

D SERIES

D - 005

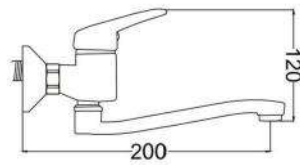

KITCHEN FAUCET

- Water saving special aerator (foam flow, lime breaker, flow rate: 8lt / min)
- Ideal working pressure 3-4 Bar
- Our product is made of MS58/MS63 brass low pressure ingots
- Surface coating is 0.16 mm chrome coating
- 360 degree rotating tube
- 25 bar pressure resistant ceramic cartridge used
- G 3/8 M-10 25 bar pressure resistant steel braided flex used



D - 006

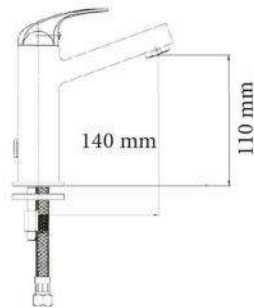

WASH BASIN FAUCET

- Water saving special aerator (foam flow, lime breaker, flow rate: 8lt / min)
- Ideal working pressure 3-4 Bar
- Our product is made of MS58/MS63 brass low pressure ingots
- Surface coating is 0.16 mm chrome coating
- 25 bar pressure resistant ceramic cartridge used
- G 3/8 M-10 25 bar pressure resistant steel braided flex used
- G 3/8 M-10 25 bar pressure resistant steel braided flex used



APLIK BATARYA

D - 007



APLIK TAKIM

D - 008

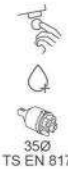
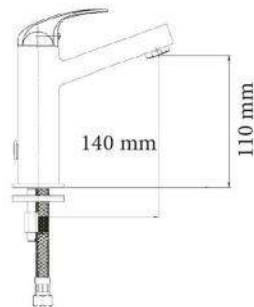

SHUT- OFF FAUCET

- Water saving special aerator (foam flow, lime breaker, flow rate: 8lt / min)
- Ideal working pressure 3-4 Bar
- Our product is made of MS58/MS63 brass low pressure ingots
- Surface coating is 0.16 mm chrome coating
- 25 bar pressure resistant ceramic cartridge used
- G 3/8 M-10 25 bar pressure resistant steel braided flex used
- Box 12 pieces



AC SERIES

AC - 001



BATHROOM FAUCET
KOLI 12

AC - 002



KITCHEN FAUCET
KOLI 12

AC - 003



EAGLE WASH BASIN FAUCET

AC - 004



SWAN FAUCET
KOLI 12

AC SERIES

AC - 005



BATHROOM FAUCET
KOLİ 12

AC - 006



SWAN FAUCET
KOLİ 12

AC - 007



WASH BASIN FAUCET

AC - 008



WASH BASIN FAUCET

AC - 009



BRIDGE FAUCET
KOLİ 12

SE SERIES

SE - 001



WASH BASIN FAUCET

SE - 002



WASH BASIN FAUCET

SE - 003



KITCHEN FAUCET
KOLI 12

SE - 004



KITCHEN FAUCET
KOLI 12

SE SERIES

SE - 005



400 TS EN 817

WASH BASIN FAUCET

SE - 006



400 TS EN 817

WASH BASIN FAUCET

SE - 007



400 TS EN 817

WASH BASIN FAUCET

SF SERIES



SF - 001 short faucet (mirrorless)

SF - 002 lux short faucet with bag



DELTA

SF - 009 delta short faucet (mirrorless)

SF - 010 delta lux short faucet with bag

SF - 011 alfa short faucet (mirrorless)

SF - 012 alfa lux short faucet with bag



ALFA



SF - 003 long faucet (mirrorless)

SF - 004 lux long faucet with bag



DELTA

SF - 013 delta long faucet (mirrorless)

SF - 014 delta lux long faucet with bag

SF - 015 alfa long faucet (mirrorless)

SF - 016 alfa lux long faucet with bag



ALFA



SF - 005 washing machine faucet (mirrorless)

SF - 006 washing machine faucet with bag



DELTA

SF - 017 delta washing machine faucet (mirrorless)

SF - 018 delta lux washing machine faucet with bag

SF - 019 alfa washing machine faucet (mirrorless)

SF - 020 alfa lux washing machine faucet with bag



ALFA



SF - 007 ball garden faucet 1/2"

SF - 008 ball garden faucet 1/4"



TI SERIES



TI - 001 toilet faucet with filter matte

TI - 002 toilet faucet with filter chrome



TI - 008 ball toilet faucet with filter chrome 3/4 1/2

TI - 009 ball toilet faucet with filter matte 3/4 1/2



TI - 003 ball washing machine faucet matte 3/4 1/2



TI - 010 intermediate faucet with filter 1/2x3/8



TI - 004 intermediate faucet with filter 1/2 3/8



TI - 011 faucet head (round)



TI - 005 Salmastra 17

TI - 006 Salmastra 15



TI SERIES



TI - 016 toilet faucet

TI - 021 star head toilet faucet



TI - 017 toilet faucet 1/2 3/8 (round)

TI - 023 toilet faucet 1/2 1/2

TI - 018 toilet faucet 1/2 1/2 (round)



TI - 019 star head toilet faucet

TI - 024 intermediate faucet



TI - 020 toilet faucet

TI - 025 plastic head toilet faucet

UZ SERIES



KROM UZATMALAR

UZ - 001	3/4" extension
UZ - 002	3/4" perforated armature extension
UZ - 003	3/4" non-perforated armature extension
UZ - 004	1/2" perforated extension
UZ - 005	3/4" washing machine faucet type "Y"



UZATMALAR

UZ - 006	1/2" chrome extension	1 cm
UZ - 007	1/2" chrome extension	1.5 cm
UZ - 008	1/2" chrome extension	2 cm
UZ - 009	1/2" chrome extension	2.5 cm
UZ - 010	1/2" chrome extension	3 cm
UZ - 011	1/2" chrome extension	4 cm
UZ - 012	1/2" chrome extension	5 cm



TSE UZATMALAR

UZ - 013	1/2" chrome extension	1 cm
UZ - 014	1/2" chrome extension	1.5 cm
UZ - 015	1/2" chrome extension	2 cm
UZ - 016	1/2" chrome extension	2.5 cm
UZ - 017	1/2" chrome extension	3 cm
UZ - 018	1/2" chrome extension	4 cm
UZ - 019	1/2" chrome extension	5 cm



3/4 UZATMALAR

UZ - 020	3/4" chrome extension	1 cm
UZ - 021	3/4" chrome extension	1.5 cm
UZ - 022	3/4" chrome extension	2 cm
UZ - 023	3/4" chrome extension	2.5 cm
UZ - 024	3/4" chrome extension	3 cm

FL SERIES



3/8x3/8

FL - 001	stainless steel braided hose connector	3/8x3/8	30 cm	25 Ad.
FL - 002	stainless steel braided hose connector	3/8x3/8	40 cm	25 Ad.
FL - 003	stainless steel braided hose connector	3/8x3/8	50 cm	25 Ad.
FL - 004	stainless steel braided hose connector	3/8x3/8	60 cm	25 Ad.
FL - 005	stainless steel braided hose connector	3/8x3/8	70 cm	25 Ad.
FL - 006	stainless steel braided hose connector	3/8x3/8	80 cm	25 Ad.
FL - 007	stainless steel braided hose connector	3/8x3/8	100 cm	25 Ad.

3/8x1/2

FL - 008	stainless steel braided hose connector	3/8x1/2	30 cm	25 Ad.
FL - 009	stainless steel braided hose connector	3/8x1/2	40 cm	25 Ad.
FL - 010	stainless steel braided hose connector	3/8x1/2	50 cm	25 Ad.
FL - 011	stainless steel braided hose connector	3/8x1/2	60 cm	25 Ad.
FL - 012	stainless steel braided hose connector	3/8x1/2	70 cm	25 Ad.
FL - 013	stainless steel braided hose connector	3/8x1/2	80 cm	25 Ad.
FL - 014	stainless steel braided hose connector	3/8x1/2	100 cm	25 Ad.

1/2x1/2

FL - 015	stainless steel braided hose connector	1/2x1/2	30 cm	25 Ad.
FL - 016	stainless steel braided hose connector	1/2x1/2	40 cm	25 Ad.
FL - 017	stainless steel braided hose connector	1/2x1/2	50 cm	25 Ad.
FL - 018	stainless steel braided hose connector	1/2x1/2	60 cm	25 Ad.
FL - 019	stainless steel braided hose connector	1/2x1/2	70 cm	25 Ad.
FL - 020	stainless steel braided hose connector	1/2x1/2	80 cm	25 Ad.
FL - 021	stainless steel braided hose connector	1/2x1/2	100 cm	25 Ad.

1/2x3/4

FL - 022	stainless steel braided hose connector	1/2x3/4	30 cm	25 Ad.
FL - 023	stainless steel braided hose connector	1/2x3/4	40 cm	25 Ad.
FL - 024	stainless steel braided hose connector	1/2x3/4	50 cm	25 Ad.
FL - 025	stainless steel braided hose connector	1/2x3/4	60 cm	25 Ad.
FL - 026	stainless steel braided hose connector	1/2x3/4	70 cm	25 Ad.
FL - 027	stainless steel braided hose connector	1/2x3/4	80 cm	25 Ad.
FL - 028	stainless steel braided hose connector	1/2x3/4	100 cm	25 Ad.

3/4x3/4

FL - 029	stainless steel braided hose connector	3/4x3/4	30 cm	25 Ad.
FL - 030	stainless steel braided hose connector	3/4x3/4	40 cm	25 Ad.
FL - 031	stainless steel braided hose connector	3/4x3/4	50 cm	25 Ad.
FL - 032	stainless steel braided hose connector	3/4x3/4	60 cm	25 Ad.
FL - 033	stainless steel braided hose connector	3/4x3/4	70 cm	25 Ad.
FL - 034	stainless steel braided hose connector	3/4x3/4	80 cm	25 Ad.
FL - 035	stainless steel braided hose connector	3/4x3/4	100 cm	25 Ad.

EB SERIES



industrial shower set

EB - 001



industrial armature (twin arms)

EB - 003



industrial shower set

EB - 002



industrial armature (one arm)

EB - 004



FU SERIES

FU - 001

armature with photocell



FU - 002

urinal faucet with photocell

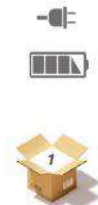

FU - 003

urinal faucet with photocell



BM SERIES



mix

BM - 001



urinal faucet

BM - 002



urinal faucet
(timed)

BM - 003



ball armature

BM - 007 3/4"

SPECIAL PRODUCTS



mix spiral kitchen armature

SP - 001



barber's armature

SP - 002



purified kitchen armature

SP - 003



purified armature

SP - 004



medical armature

SP - 005

VINTAGE SERIES



VT - 001

porcelain arm mix chrome armature



VT - 002

porcelain arm mix black armature



VT - 003

porcelain arm mix gold armature



VT - 004

porcelain arm mix antique armature

VINTAGE SERIES



VT - 005

ottoman bathroom armature antique



VT - 006

ottoman kitchen armature antique



VT - 007

ottoman swan armature antique



VT - 008

ottoman eagle armature antique



VT - 009

1/2 ottoman faucet yellow

VT - 010

1/2 ottoman faucet antique

VT - 011

1/2 ottoman faucet retro



(for garden hose)

VT - 012

1/2 ottoman faucet yellow

VT - 013

1/2 ottoman faucet antique

VT - 014

1/2 ottoman faucet retro

PD SERIES



ARMONI BLACK

PD - 001



ARMONI GOLD

PD - 002



ARMONI CHROME

PD - 003



AD SERIES



AD - 001



AD - 002



Lotus built-in shower set

AD - 003



Royal built-in shower set

AD - 004



SHOWER SYSTEMS



JAGUAR BLACK

SS - 001



JAGUAR GOLD

SS - 002



JAGUAR CHROME

SS - 003



JAGUAR GREY

SS - 004



ZEBRA BLACK

SS - 005

SHOWER SYSTEMS



TIGER

SS - 006



PARS BLACK

SS - 007



KUMRU

SS - 008



GÜVERCİN

SS - 009



MARTI

SS - 010



BUFALO

SS - 011

SHOWER SYSTEMS



GÜVERCİN
SS - 012



MARTI
SS - 013



JAGUAR
SS - 014



ZEBRA
SS - 015



SAMUR
SS - 016



MARTI
SS - 017



JAGUAR
SS - 018



ZEBRA
SS - 019



DELUXE ÖRGÜLÜ
SS - 020



SS - 022 WHITE



SS - 023 CHROME



SS - 024 BLACK



SS - 025 GOLD



SS - 021



VV SERIES



Whatnot



VV - 001



Robe hook



VV - 002



Toothbrush holder

VV - 003



Soap dish

VV - 004



Toilet paper holder

VV - 005



Toilet paper holder 2

VV - 006



Round Towel Holder

VV - 007



Long Towel Holder

VV - 008



Glass toilet brush

VV - 009



VV GOLD SERIES



Whatnot

VVG - 001



Robe hook

VVG - 002



Toothbrush holder

VVG - 003



Soap dish

VVG - 004



Toilet paper holder

VVG - 005



Toilet paper holder 2

VVG - 006



Round Towel Holder

VVG - 007



Long Towel Holder

VVG - 008



Glass toilet brush

VVG - 009

VV SHADOW SERIES



Whatnot

VVS - 001



Robe hook

VVS - 002



Toothbrush holder

VVS - 003



Soap dish

VVS - 004



Toilet paper holder

VVS - 005



Toilet paper holder 2

VVS - 006



Round Towel Holder

VVS - 007



Long Towel Holder

VVS - 008



Glass toilet brush

VVS - 009

SR SERIES



Long Towel Holder

SR - 001



Robe hook

SR - 002



Toothbrush holder

SR - 003



Soap dish

SR - 004



Toilet paper holder

SR - 005



Toilet paper holder 2

SR - 006



Round Towel Holder

SR - 007

SR SHADOW SERIES



Long Towel Holder

SRS - 001



Robe hook

SRS - 002



Toothbrush holder

SRS - 003



Soap dish

SRS - 004



Toilet paper holder

SRS - 005



Toilet paper holder 2

SRS - 006



Round Towel Holder

SRS - 007

TN SERIES



Whatnot

TN - 001



Robe hook

TN - 002



Toothbrush holder

TN - 003



Soap dish

TN - 004



Toilet paper holder

TN - 005



Toilet paper holder 2

TN - 006



Round Towel Holder

TN - 007



Long Towel Holder

TN - 008

AR SERIES



Long Towel Holder

AR - 001



Robe hook

AR - 002



Toothbrush holder

AR - 003



Soap dish

AR - 004



Toilet paper holder

AR - 005



Toilet paper holder 2

AR - 006



Round Towel Holder

AR - 007

AR SHADOW



Long Towel Holder

ARS - 001



Robe hook

ARS - 002



Toothbrush holder

ARS - 003



Soap dish

ARS - 004



Toilet paper holder

ARS - 005



Toilet paper holder 2

ARS - 006



Round Towel Holder

ARS - 007

LS SERIES



Wall mounted bathroom shelf unit

LS - 001 18x18 Tier 1 36 Pcs.

LS - 002 18x18 Tier 2 18 Pcs.

LS - 003 18x18 Tier 3 12 Pcs.



Wall mounted bathroom shelf unit

LS - 004 18x18 Tier 1 36 Pcs.

LS - 005 18x18 Tier 2 18 Pcs.

LS - 006 18x18 Tier 3 12 Pcs.



Wall mounted bathroom shelf unit

LS - 007 20x20 Tier 1 36 Pcs.

LS - 008 20x20 Tier 2 18 Pcs.

LS - 009 20x20 Tier 3 12 Pcs.



Wall mounted bathroom shelf unit

LS - 010 20x20 Tier 1 36 Pcs.

LS - 011 20x20 Tier 2 18 Pcs.

LS - 012 20x20 Tier 3 12 Pcs.



Wall mounted bathroom shelf unit

LS - 013 20x20 Tier 1 36 Pcs.

LS - 014 20x20 Tier 2 18 Pcs.

LS - 015 20x20 Tier 3 12 Pcs.

KV SERIES



KV - 001 Intermediate shut-off valve 20 mm

KV - 002 Intermediate shut-off valve 25 mm



KV - 003 Intermediate shut-off valve 20 mm

KV - 004 Intermediate shut-off valve 25 mm



KV - 005 Intermediate shut-off valve 20 mm

KV - 006 Intermediate shut-off valve 25 mm



KV - 007 Intermediate shut-off valve 20 mm

KV - 008 Intermediate shut-off valve 25 mm



KV - 009 Intermediate shut-off valve 20 mm

KV - 010 Intermediate shut-off valve 25 mm



KV - 011 Intermediate shut-off valve 20 mm

KV - 012 Intermediate shut-off valve 25 mm



KV - 013 Intermediate shut-off valve 20 mm

KV - 014 Intermediate shut-off valve 25 mm







KV - 015 Intermediate shut-off valve 20 mm

KV - 016 Intermediate shut-off valve 25 mm



KK SERIES







-  Easy Montage
-  Silence and close slowly
-  Clean easily
-  Two year warranty

Toilet seat cover

KK - 001



-  Easy Montage
-  Silence and close slowly
-  Clean easily
-  Two year warranty

Toilet seat cover

KK - 002



Built-in toilet top module

KK - 003



KK - 004 Normal top module interior kit with button

SHOWER DRAIN CHANNEL



Long Shower Drain

SDC - 001	Long Shower Drain	Ø50	33 cm
SDC - 002	Long Shower Drain	Ø50	40 cm
SDC - 003	Long Shower Drain	Ø50	50 cm
SDC - 004	Long Shower Drain	Ø50	60 cm
SDC - 005	Long Shower Drain	Ø50	80 cm



Long Shower Drain Type2

SDC - 006	Long Shower Drain	Ø50	33 cm
SDC - 007	Long Shower Drain	Ø50	40 cm
SDC - 008	Long Shower Drain	Ø50	50 cm
SDC - 009	Long Shower Drain	Ø50	60 cm
SDC - 010	Long Shower Drain	Ø50	80 cm



10x10 Square Shower Drain

SDC - 011	Shower Drain	Ø 32	Side unload
SDC - 012	Shower Drain	Ø 50	Side unload
SDC - 013	Shower Drain	Ø 50	Bottom unload



15x15 Square Shower Drain

SDC - 014	Shower Drain	Ø 32	Side unload
SDC - 015	Shower Drain	Ø 50	Side unload
SDC - 016	Shower Drain	Ø 50	Bottom unload



Avrasia

Bathroom
Cabinet

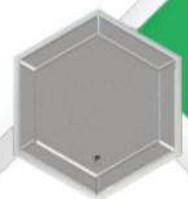

DARKNESS

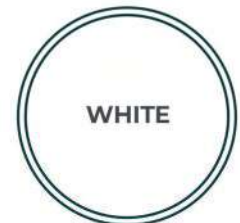
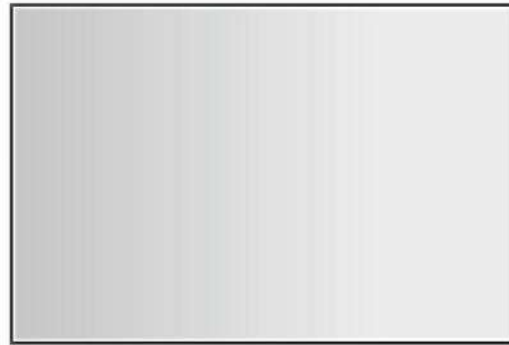

MIRAGE

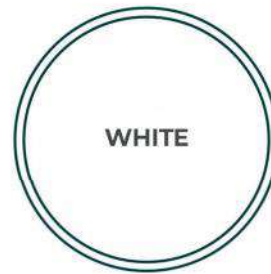

VULCAN



VULCAN

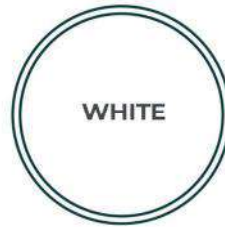
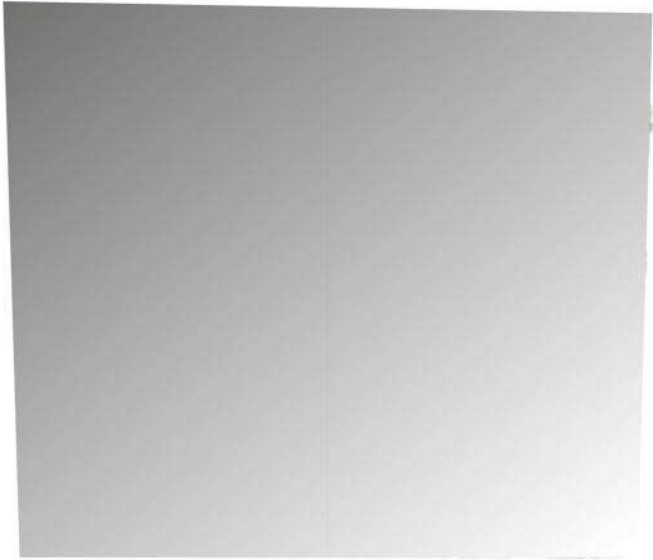

ATLAS

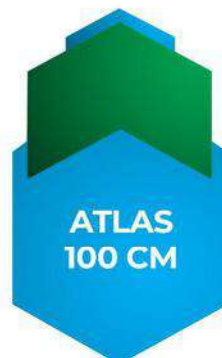
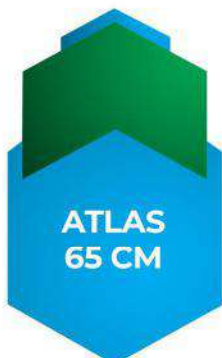



STONE



VINTAGE





SAND

WHITE

CYRSTAL

ANTHRACITE

WOOD

SAND
65 CM

SAND
80 CM

SAND
100 CM

TOWEL
CABINET
35x150 CM

HYPNOS

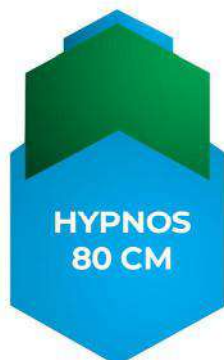
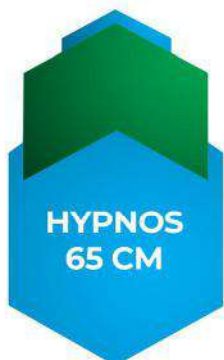



SOFT

WHITE

CYRSTAL

ANTHRACITE

WOOD

SOFT
65 CM

SOFT
80 CM

SOFT
100 CM

TOWEL
CABINET
35x150 CM

BLACK FOREST



DIANA



VENUS



DONE TO DEATH



VALLEY



BREEZE



FAMILY



WHITE

CYRSTAL

ANTHRACITE

WOOD

FAMILY
65 CM

FAMILY
80 CM

FAMILY
100 CM

TOWEL
CABINET
35x150 CM

WOOD LINE



ECONOMIC



WHITE

CYRSTAL

ANTHRACITE

WOOD

ECONOMIC
65 CM

ECONOMIC
80 CM

ECONOMIC
100 CM

TOWEL
CABINET
35x150 CM

MIDNIGHT



MINI - 050



MINI - 045



ABIS

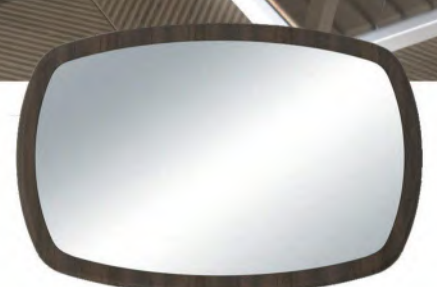
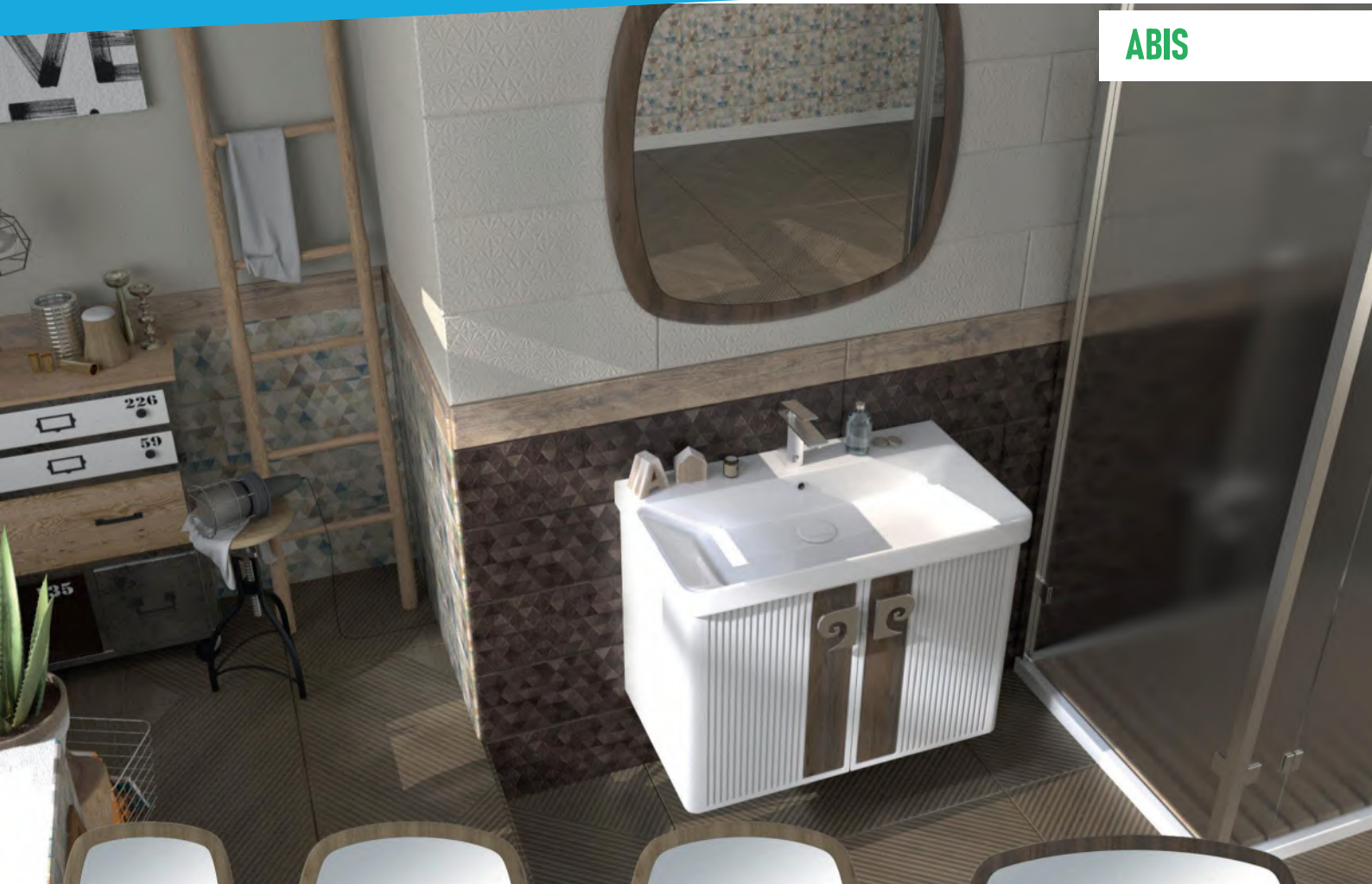

ABIS



ABIS 60

⊗ ÖLÇÜLER / DIMENSIONS

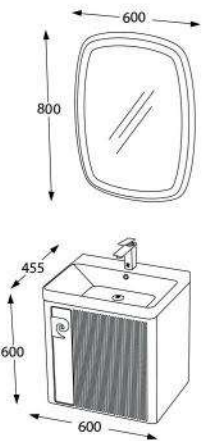

ABIS 80

⊗ ÖLÇÜLER / DIMENSIONS

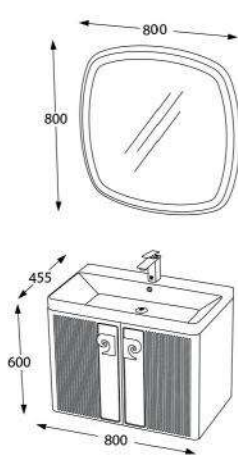

ABIS 105

⊗ ÖLÇÜLER / DIMENSIONS

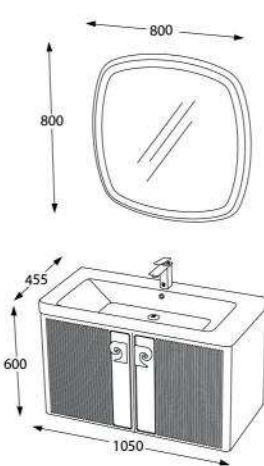

ABIS 120

⊗ ÖLÇÜLER / DIMENSIONS

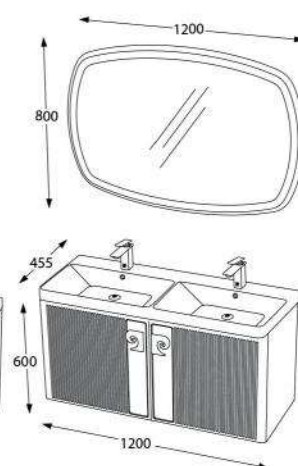

ABIS BOY L

⊗ ÖLÇÜLER / DIMENSIONS

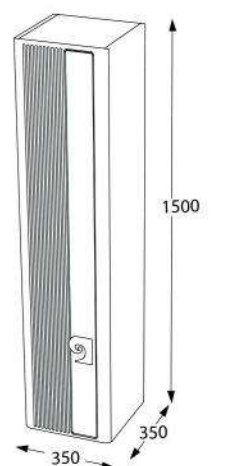



EVA



White Gold

White Chrome

White Swan



Black Gold

Black Chrome

Black Swan

EVA 101

ÖLÇÜLER / DIMENSIONS

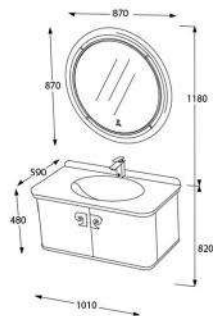

EVA 80Y

ÖLÇÜLER / DIMENSIONS

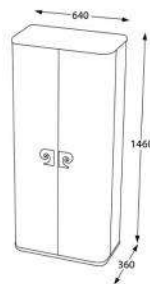



ATLANTIC



ATLANTIC 80

ÖLÇÜLER / DIMENSIONS

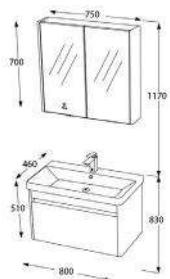

ATLANTIC 60

ÖLÇÜLER / DIMENSIONS

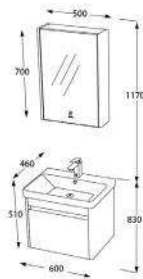

ATLANTIC 105

ÖLÇÜLER / DIMENSIONS

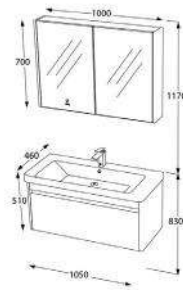

ANTİC YARIM BOY

ÖLÇÜLER / DIMENSIONS

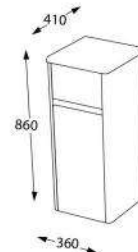

İY

DİMENSİYONLAR

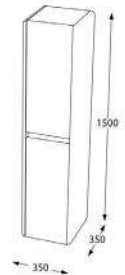

ANEMON

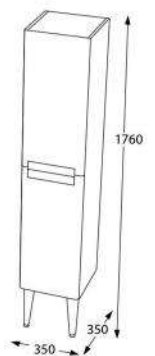
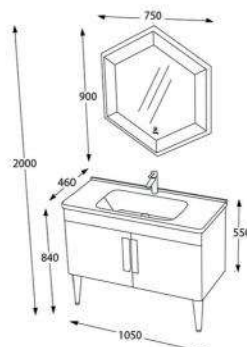
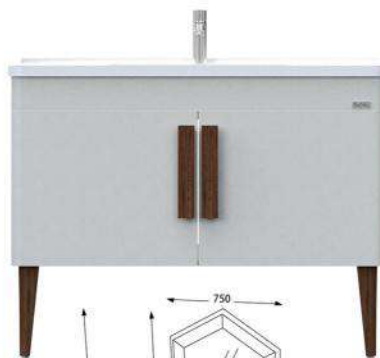
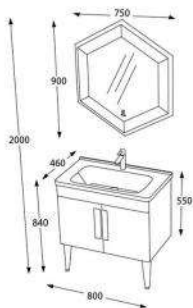
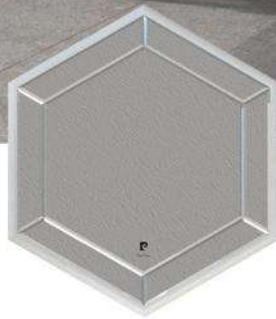



NORMAN



NORMAN 55

NORMAN 70

NORMAN 85

NORMAN 100

NORMAN BOY

ÖLÇÜLER / DIMENSIONS

ÖLÇÜLER / DIMENSIONS

ÖLÇÜLER / DIMENSIONS

ÖLÇÜLER / DIMENSIONS

ÖLÇÜLER / DIMENSIONS

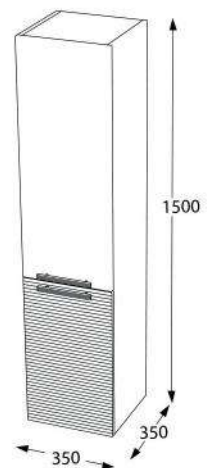
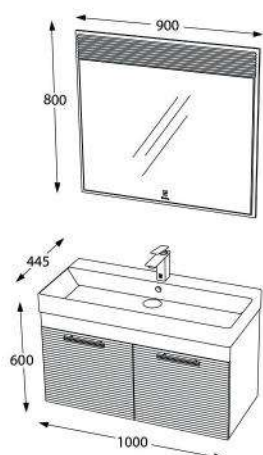
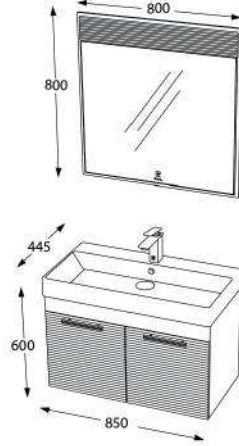
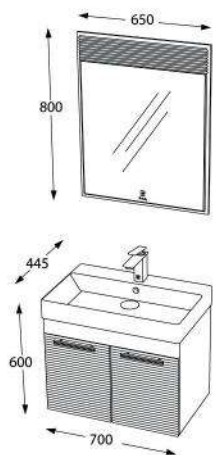
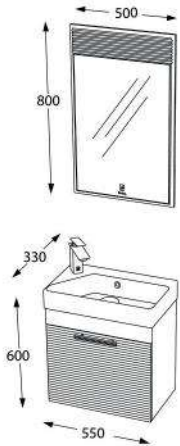



PACIFIC 60

PACIFIC 80

PACIFIC 105

PACIFIC BOY

PACIFIC YARIM BOY

📏 ÖLÇÜLER / DIMENSIONS

📏 ÖLÇÜLER / DIMENSIONS

📏 ÖLÇÜLER / DIMENSIONS

📏 ÖLÇÜLER / DIMENSIONS

📏 ÖLÇÜLER / DIMENSIONS

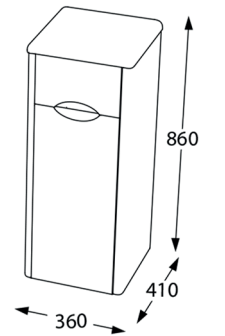
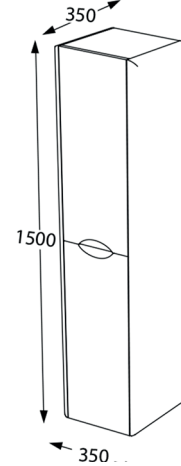
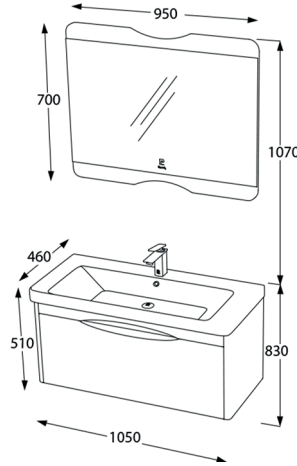
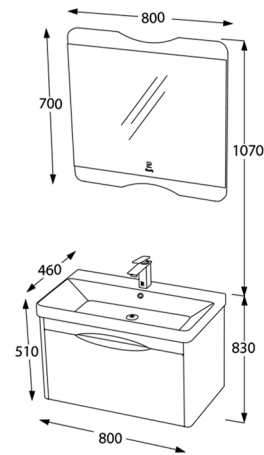
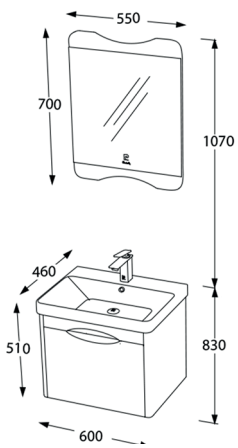

PIO



PIO 65

ÖLÇÜLER / DIMENSIONS

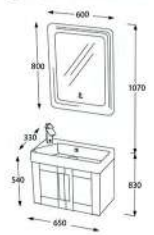

PIO 70

ÖLÇÜLER / DIMENSIONS

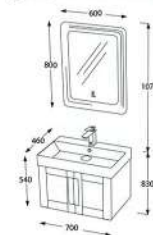

PIO 85

ÖLÇÜLER / DIMENSIONS

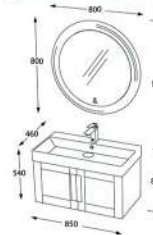

PIO 100

ÖLÇÜLER / DIMENSIONS

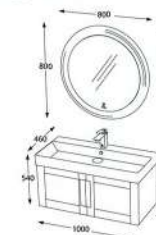

PIO 120

ÖLÇÜLER / DIMENSIONS

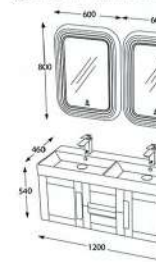

PIO BOY

ÖLÇÜLER / DIMENSIONS

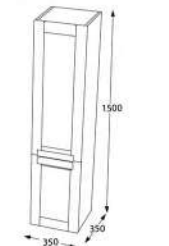

RATA

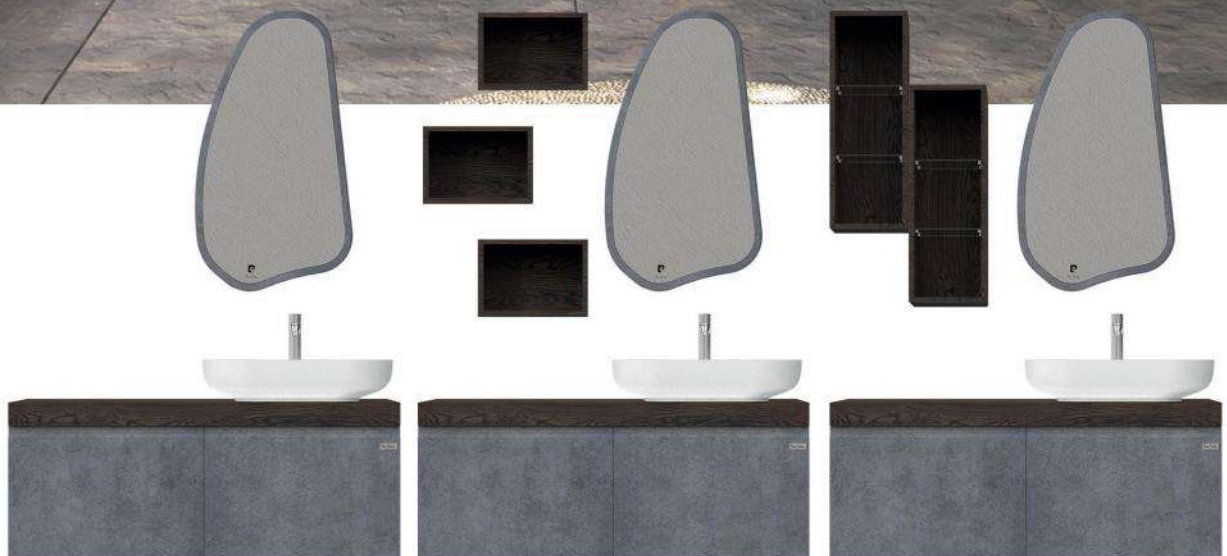

RATA



RATA 90

ÖLÇÜLER / DIMENSIONS

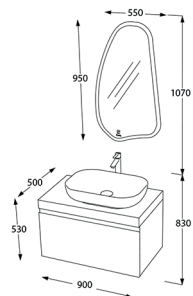

RATA 120

ÖLÇÜLER / DIMENSIONS

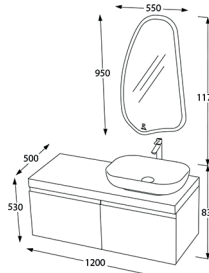

RATA 120 STYLE 01

ÖLÇÜLER / DIMENSIONS

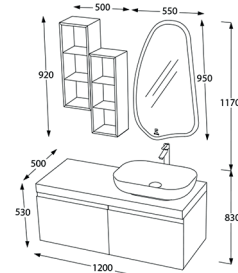

RATA 120 STYLE 02

ÖLÇÜLER / DIMENSIONS

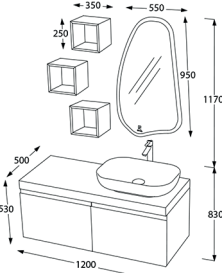

RATA 120 STYLE 03

ÖLÇÜLER / DIMENSIONS

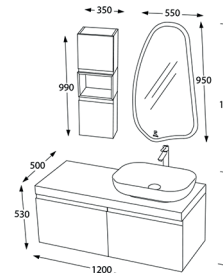

RATA 120 STYLE 04

ÖLÇÜLER / DIMENSIONS

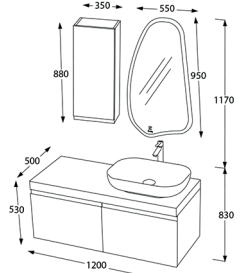

SIRIU



SIRIUS 100

📏 ÖLÇÜLER / DIMENSIONS

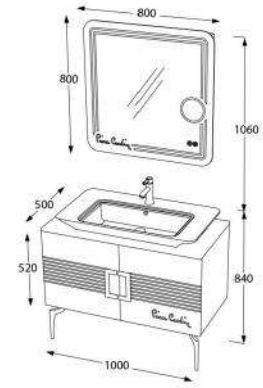

SIRIUS BOY

📏 ÖLÇÜLER / DIMENSIONS

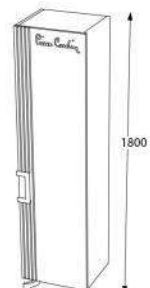

STAR

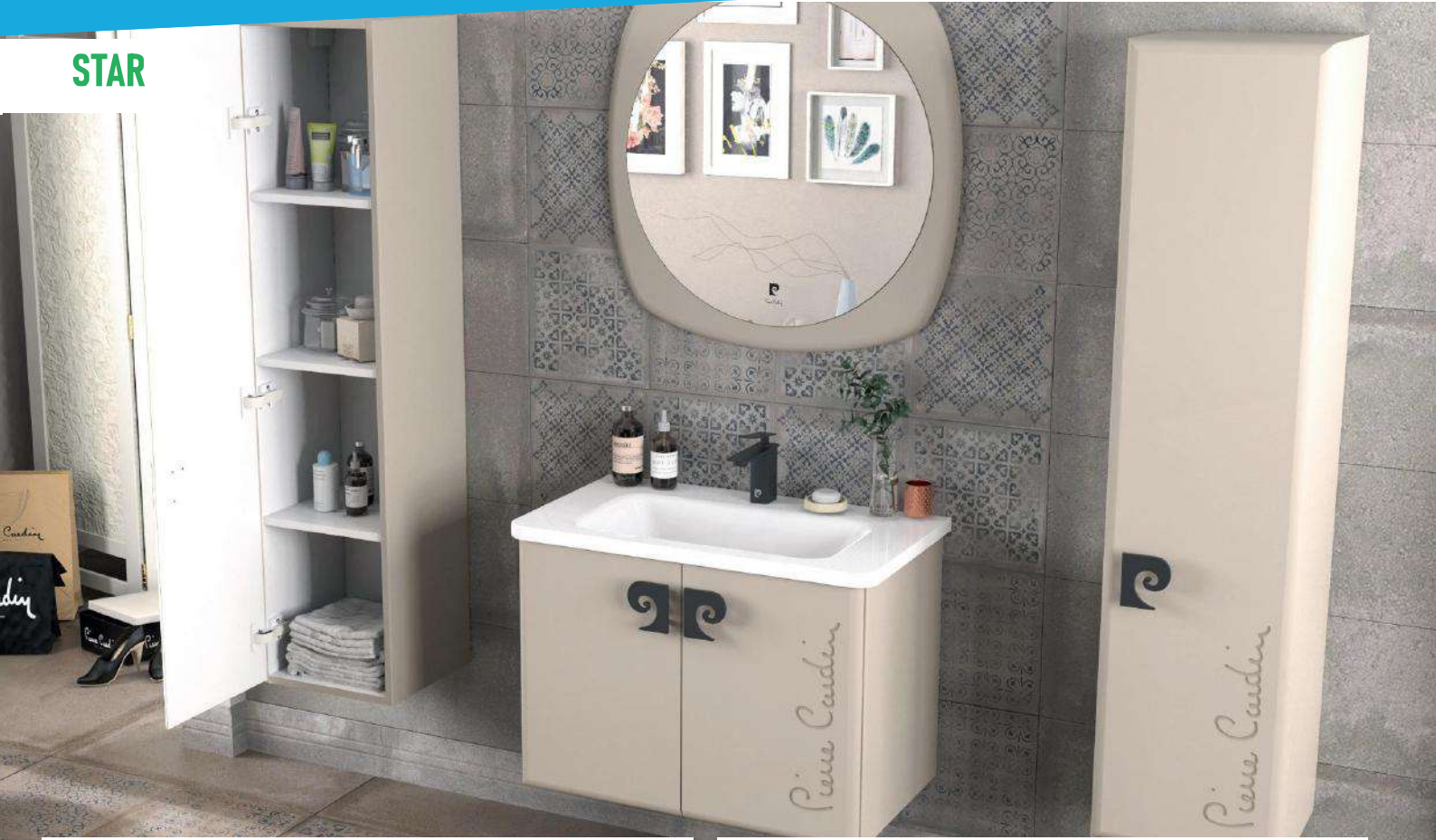

STAR 60

ÖLÇÜLER / DIMENSIONS

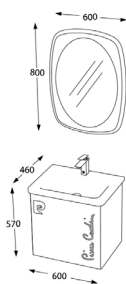

STAR 80

ÖLÇÜLER / DIMENSIONS

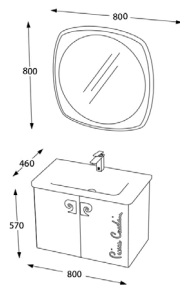

STAR 105

ÖLÇÜLER / DIMENSIONS

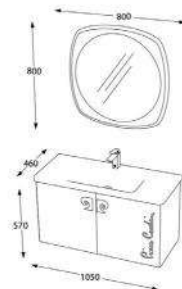

STAR BOY L

ÖLÇÜLER / DIMENSIONS

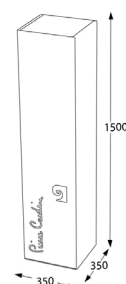

SUN

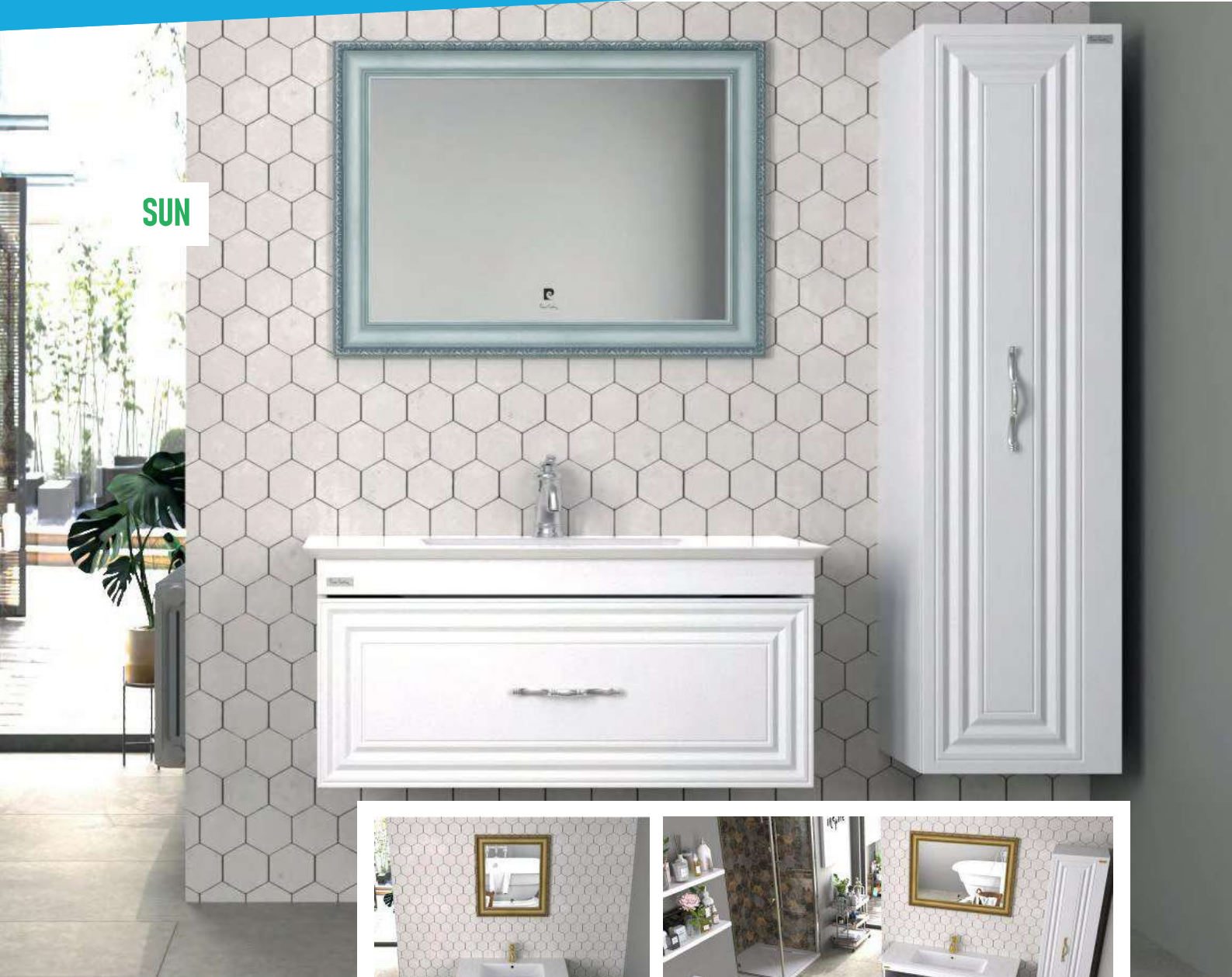

SUN 70

ÖLÇÜLER / DIMENSIONS

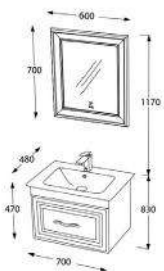

SUN 90

ÖLÇÜLER / DIMENSIONS

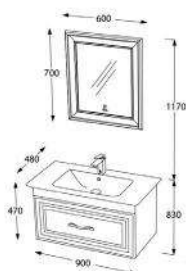

SUN 105

ÖLÇÜLER / DIMENSIONS

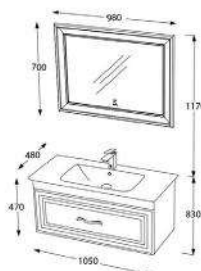

SUN 120

ÖLÇÜLER / DIMENSIONS

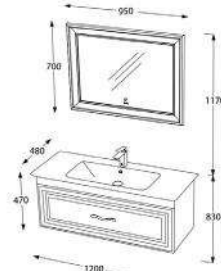

SUN BOY

ÖLÇÜLER / DIMENSIONS

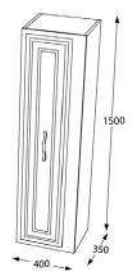

UFFIZI

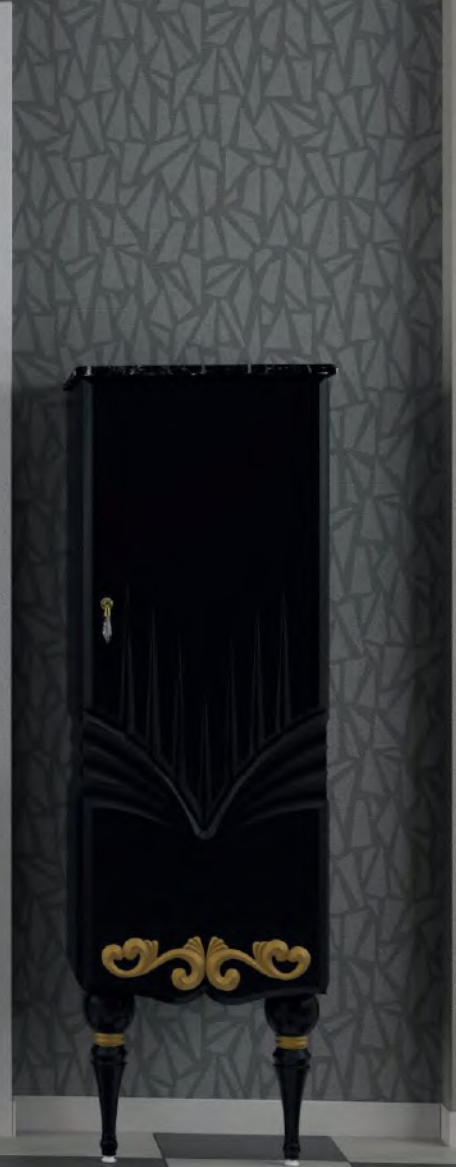
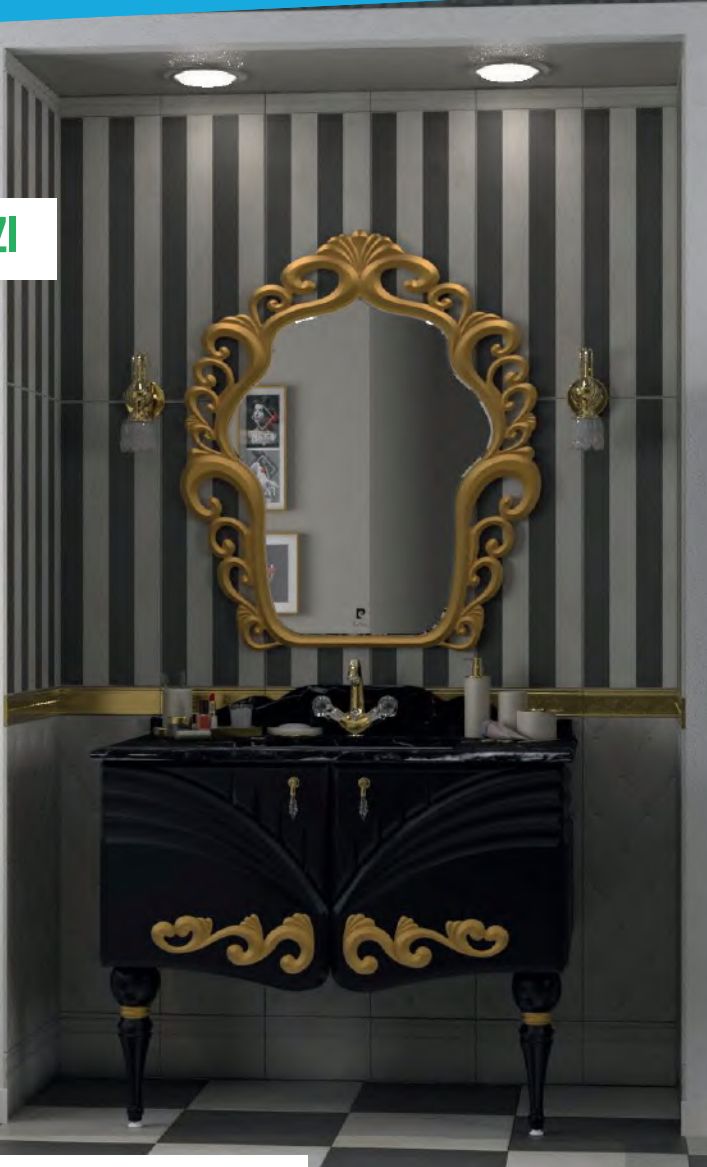

UFFIZI 106

ÖLÇÜLER / DIMENSIONS

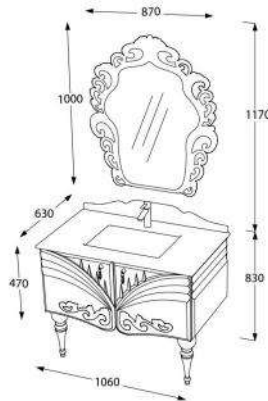

UFFIZI BOY

ÖLÇÜLER / DIMENSIONS

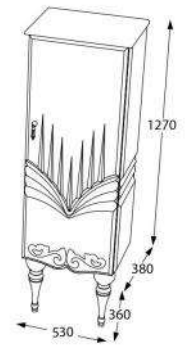

VEGA



VEGA 100

ÖLÇÜLER / DIMENSIONS

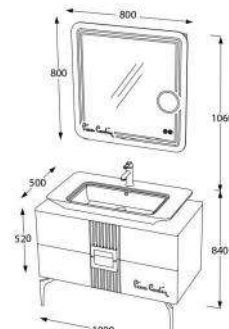

VEGA BOY

ÖLÇÜLER / DIMENSIONS

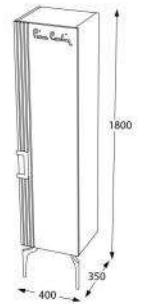



VENUS



VENUS 120

ÖLÇÜLER / DIMENSIONS

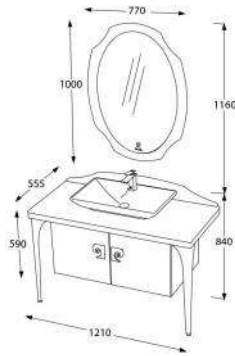

VENUS BOY

ÖLÇÜLER / DIMENSIONS



WINTER



WINTER 70

ÖLÇÜLER / DIMENSIONS

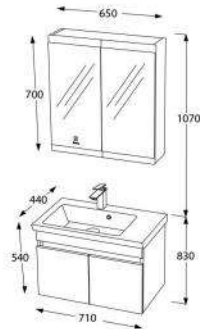

WINTER 85

ÖLÇÜLER / DIMENSIONS

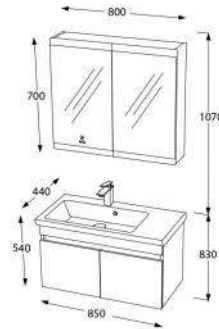

WINTER 100

ÖLÇÜLER / DIMENSIONS

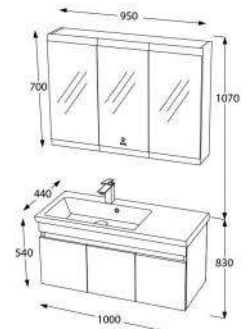

ZEN



ZEN 55

ÖLÇÜLER / DIMENSIONS

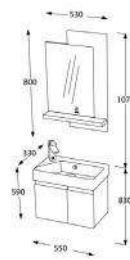

ZEN 65

ÖLÇÜLER / DIMENSIONS



ZEN 70

ÖLÇÜLER / DIMENSIONS

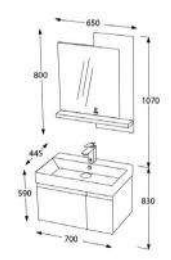

ZEN 85

ÖLÇÜLER / DIMENSIONS

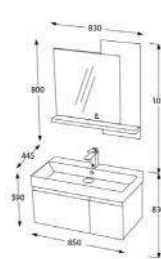

ZEN 100

ÖLÇÜLER / DIMENSIONS

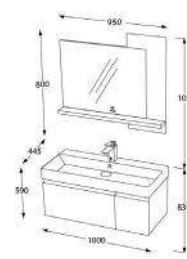

ZEN 80Y

ÖLÇÜLER / DIMENSIONS

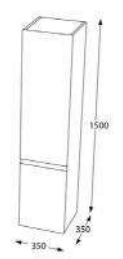

Avrasia

Wooden Door



Mare

HM-001

Melamin Yüzey
Melamine Surface



Mons HM-002

Melamin Yüzey
Melamine Surface





LUX

HM-003

Melamin Yüzey
Melamine Surface

Ventus HM-004

Melamin Yüzey
Melamine Surface



Lune

HM-005

Melamin Yüzey
Melamine Surface



Monde HM-006

Melamin Yüzey
Melamine Surface



Terra

HM-007

Melamin Yüzey
Melamine Surface



Anka **HM-008**

Melamin Yüzey
Melamine Surface



Amor

HM-009

Melamin Yüzey
Melamine Surface



Rânâ

HM-010

Melamin Yüzey
Melamine Surface



i
lhyâ

HM-011

Melamin Yüzey
Melamine Surface



Porta

HM-012

Melamin Yüzey
Melamine Surface



Dublin HM-013

Pvc Yüzey
Pvc Surface



Rose **HM-014**

Pvc Yüzey
Pvc Surface



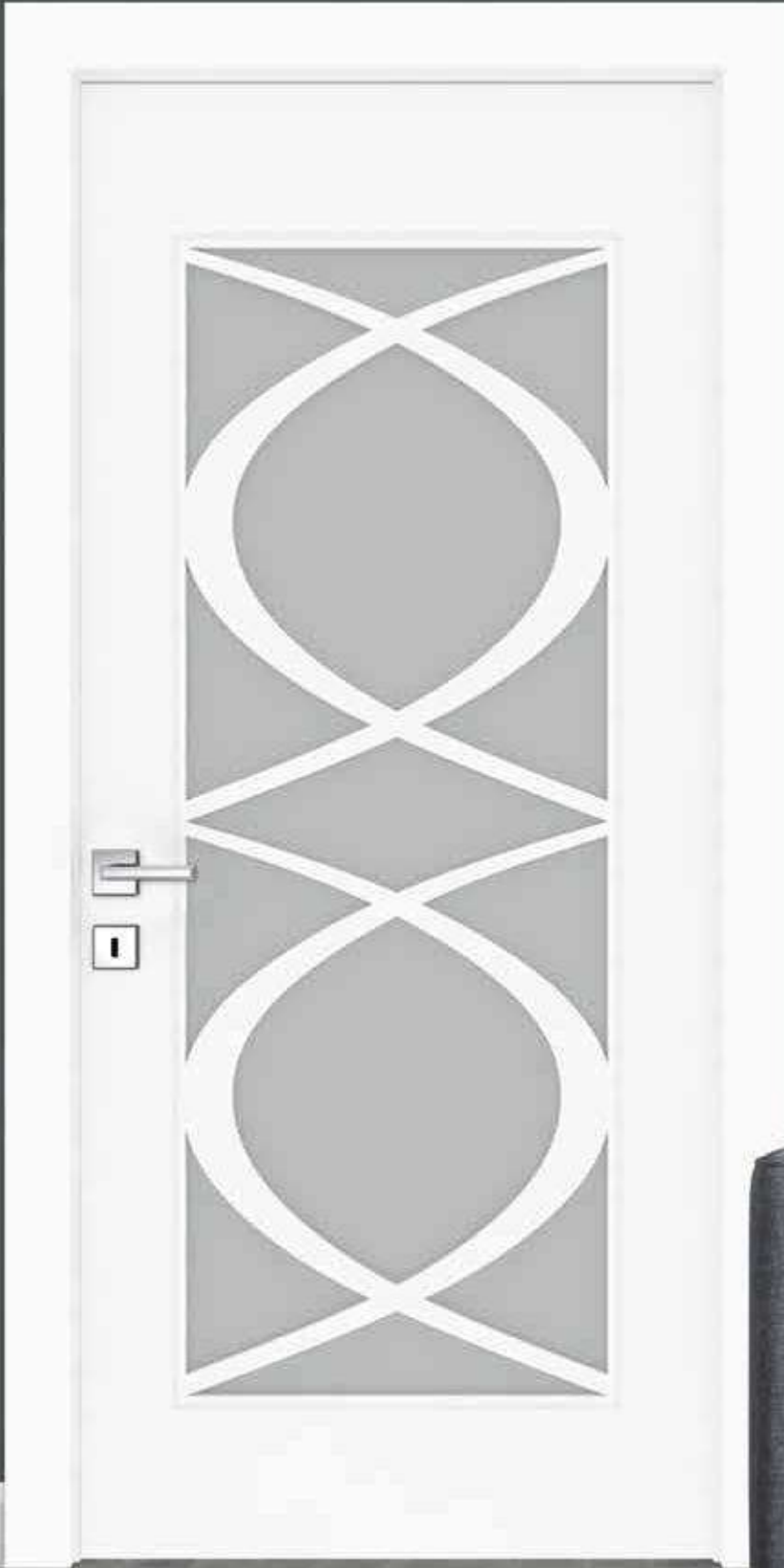

Lome HM-015

Pvc Yüzey
Pvc Surface



Sierra

HM-016

Pvc Yüzey
Pvc Surface



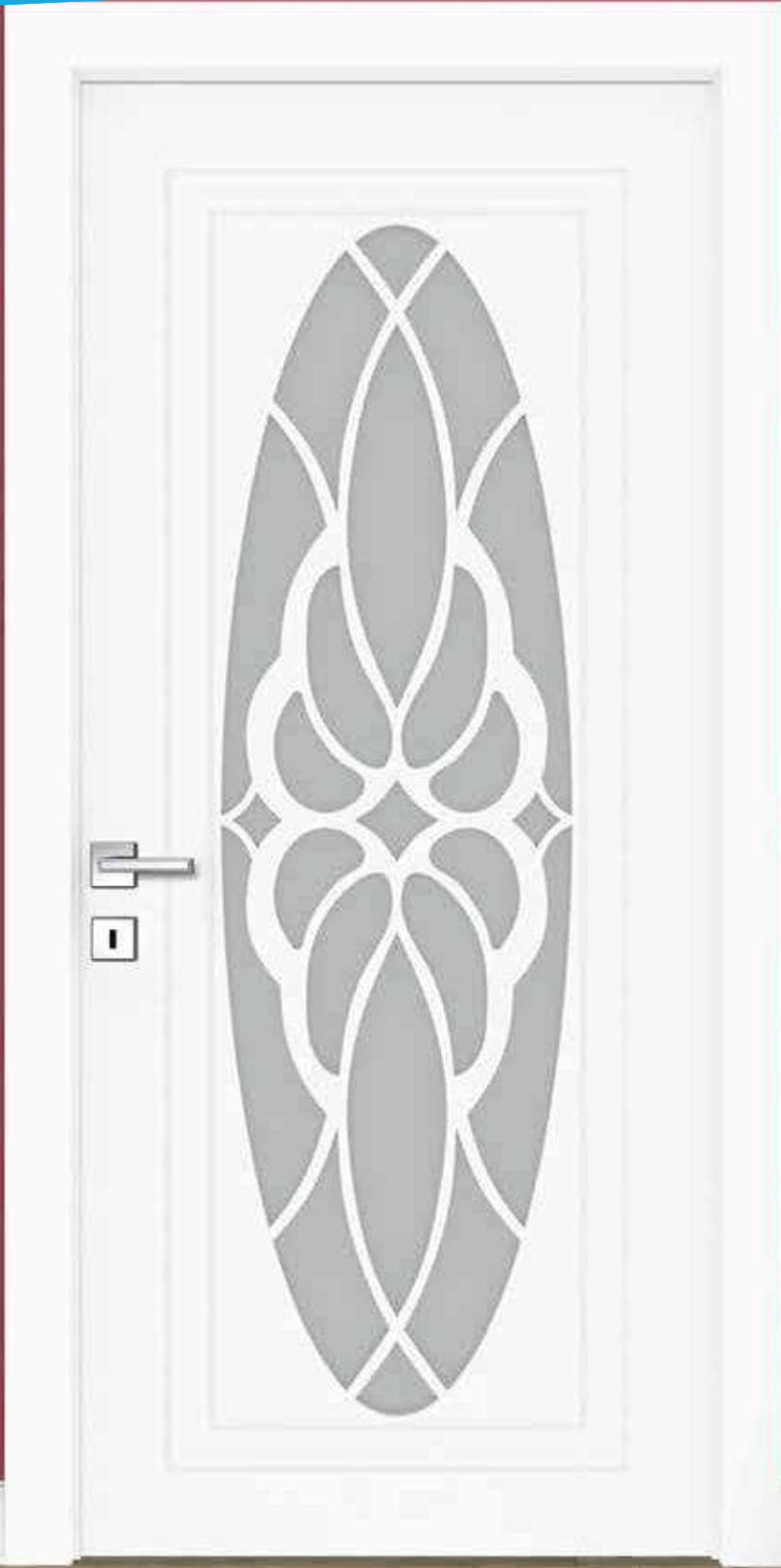

Lima **HM-017**

Pvc Yüzey
Pvc Surface



Riga

HM-018

Pvc Yüzey
Pvc Surface





Viet

HM-019

Pvc Yüzey
Pvc Surface

Laos **HM-020**

Pvc Yüzey
Pvc Surface





Togo **HM-021**

Pvc Yüzey
Pvc Surface



Tokyo

HM-022

Pvc Yüzey
Pvc Surface



Boston **HM-023**

Ahşap Yüzey
Wood Surface





Line **HM-024**

Ahşap Yüzey
Wood Surface



Sevilla

HM-025

Ahşap Yüzey
Wood Surface



Mega

HM-026

Ahşap Yüzey
Wood Surface



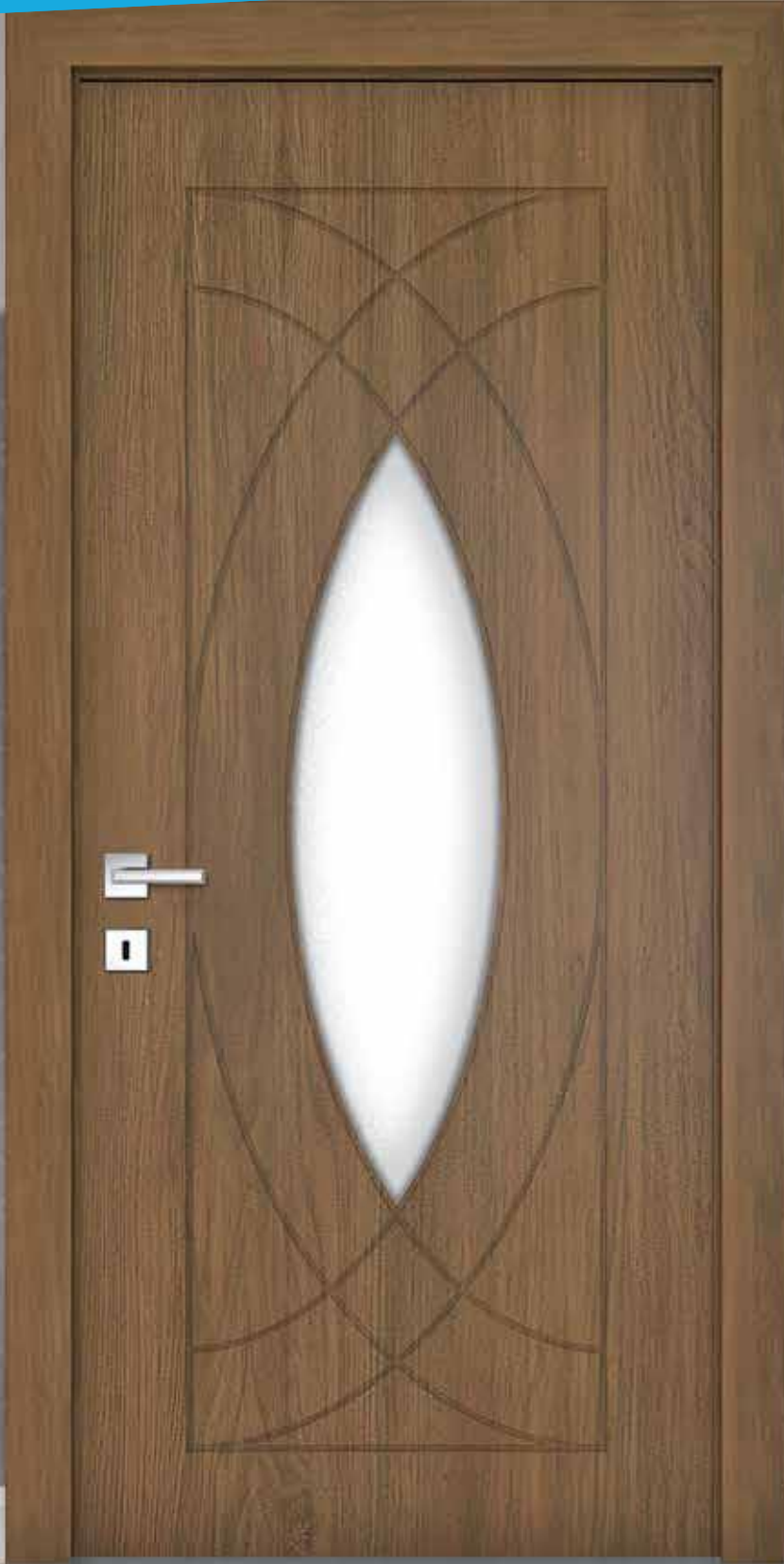

Peru

HM-027

Ahşap Yüzey
Wood Surface

Timber

HM-028

Ahşap Yüzey
Wood Surface



Belize

HM-029

Lake Uygulama
Applying Lacquer

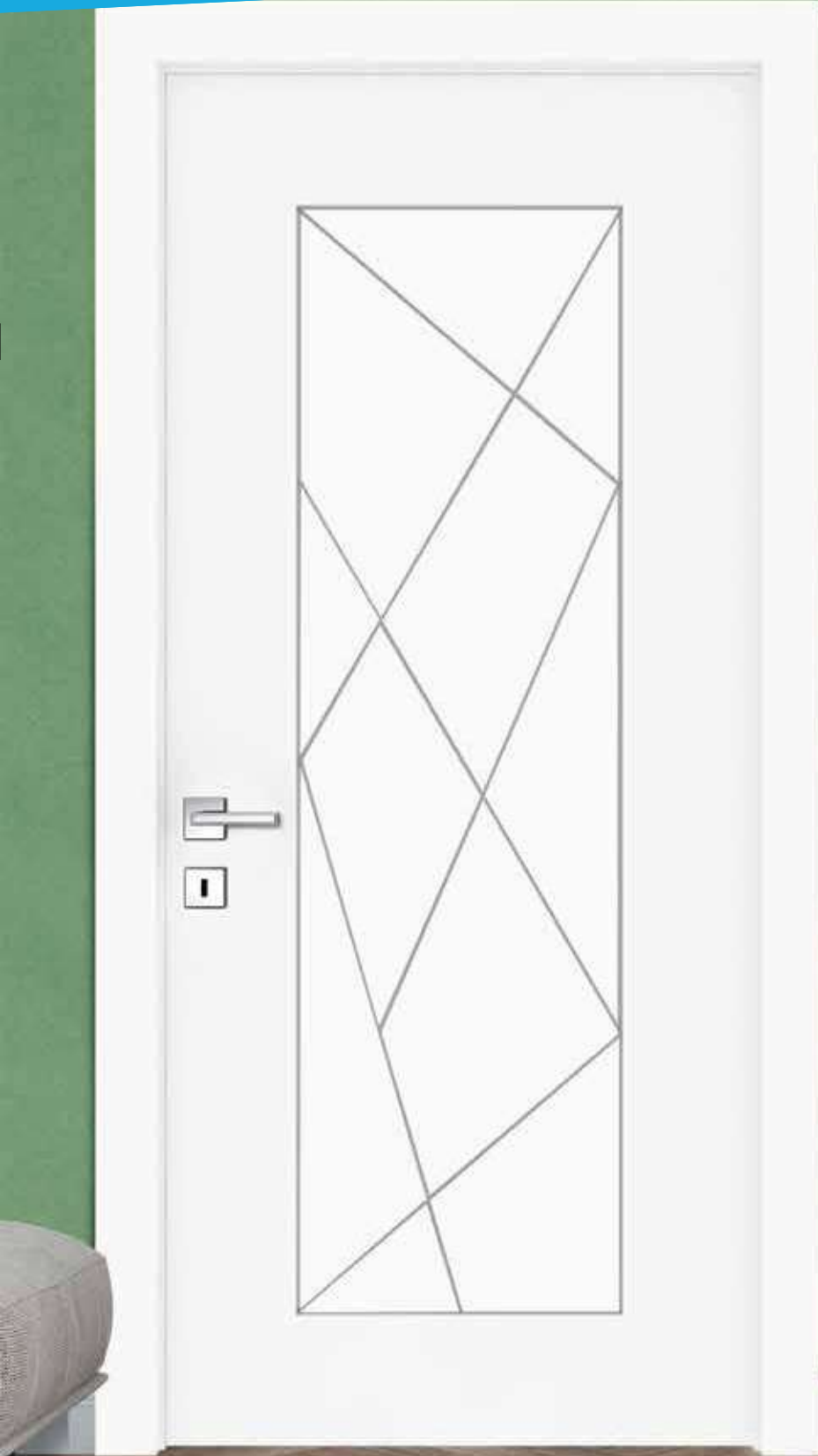

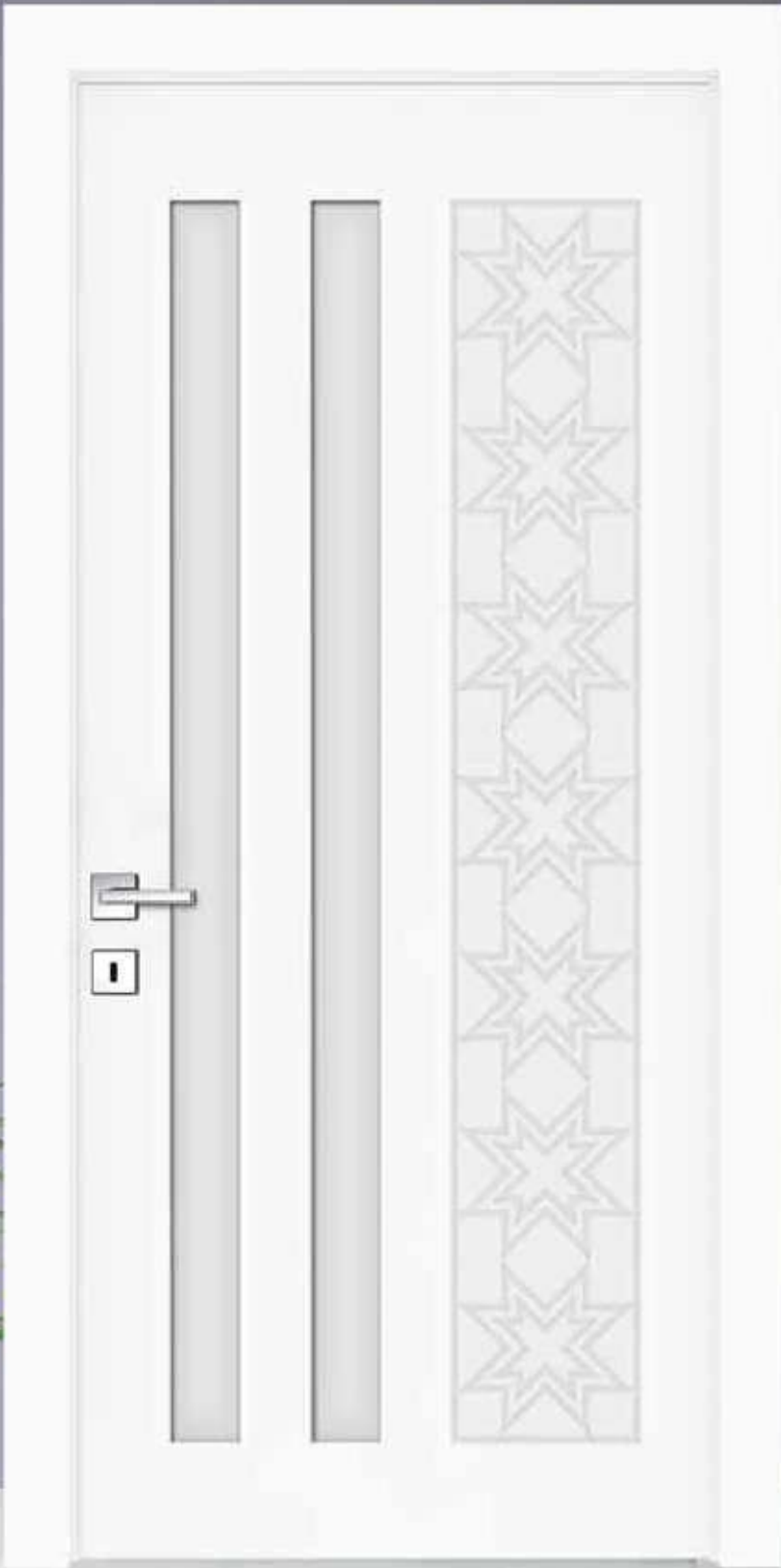

Suva HM-030

Lake Uygulama
Applying Lacquer



Wit

HM-032

Lake Uygulama
Applying Lacquer



Gray

HM-033

Lake Uygulama
Applying Lacquer



Nancy

HM-034

Lake Uygulama
Applying Lacquer

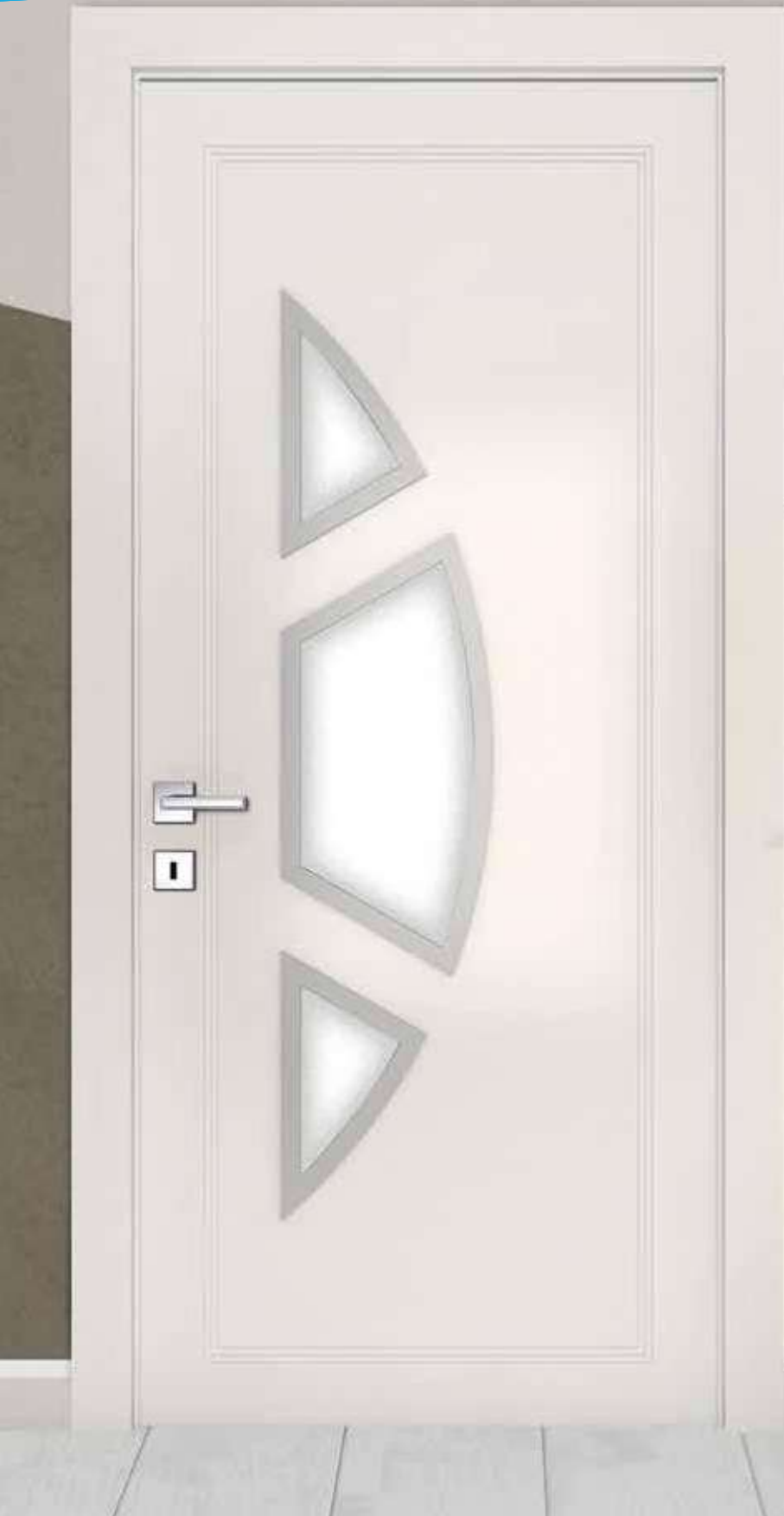

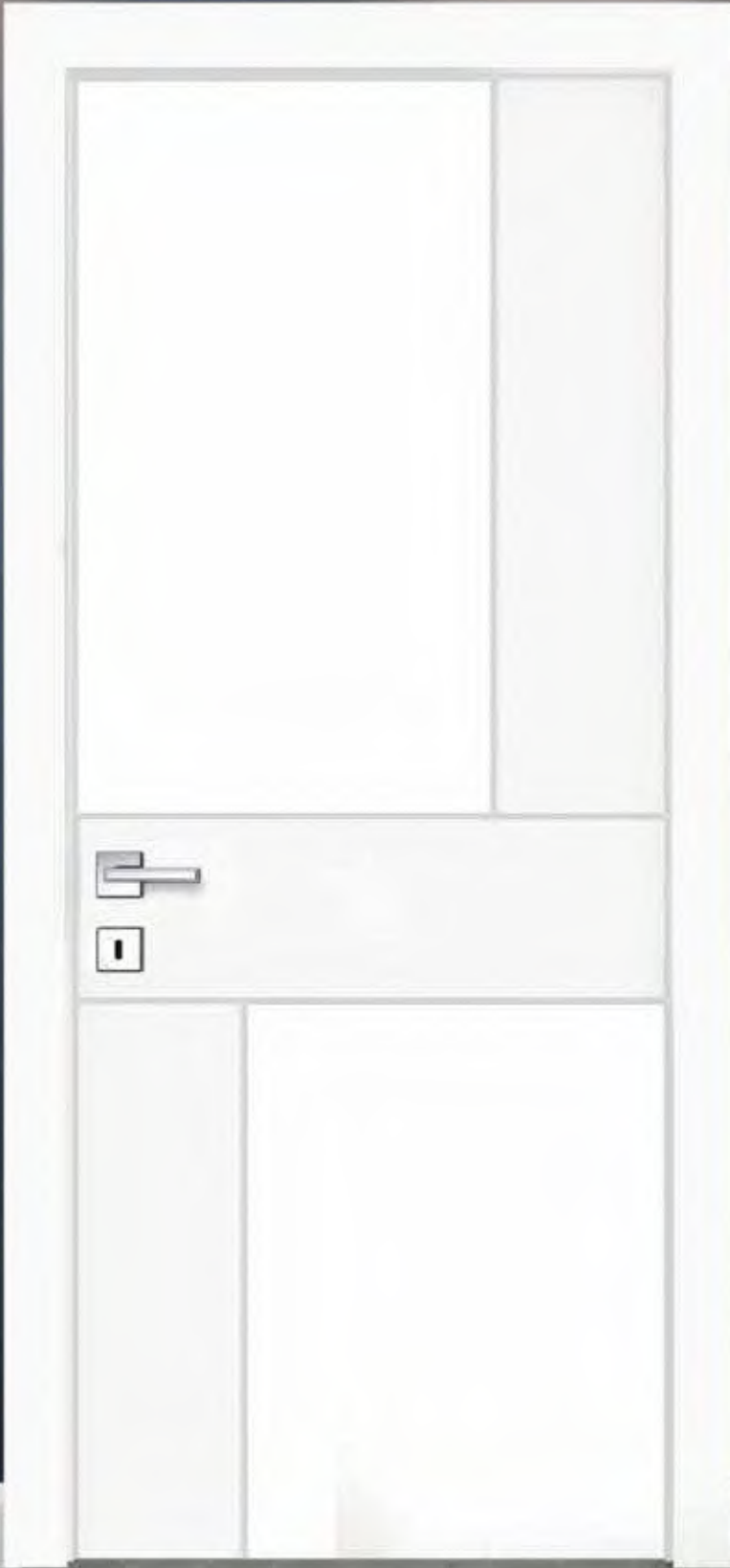

Sofya

HM-035

Lake Uygulama
Applying Lacquer



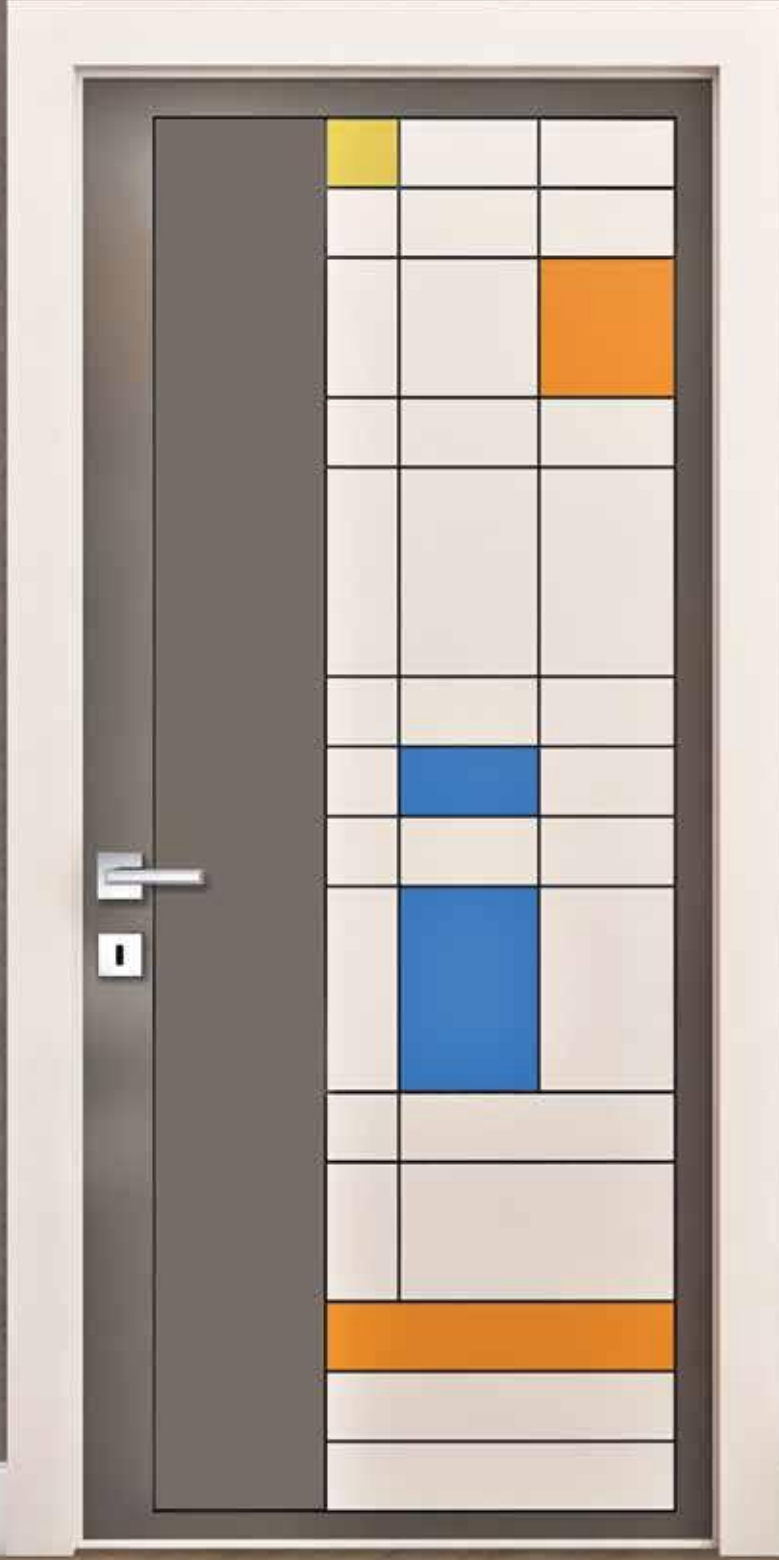

London

HM-036

Exclusive Lake Yüzey
Exclusive Lacquer Surface



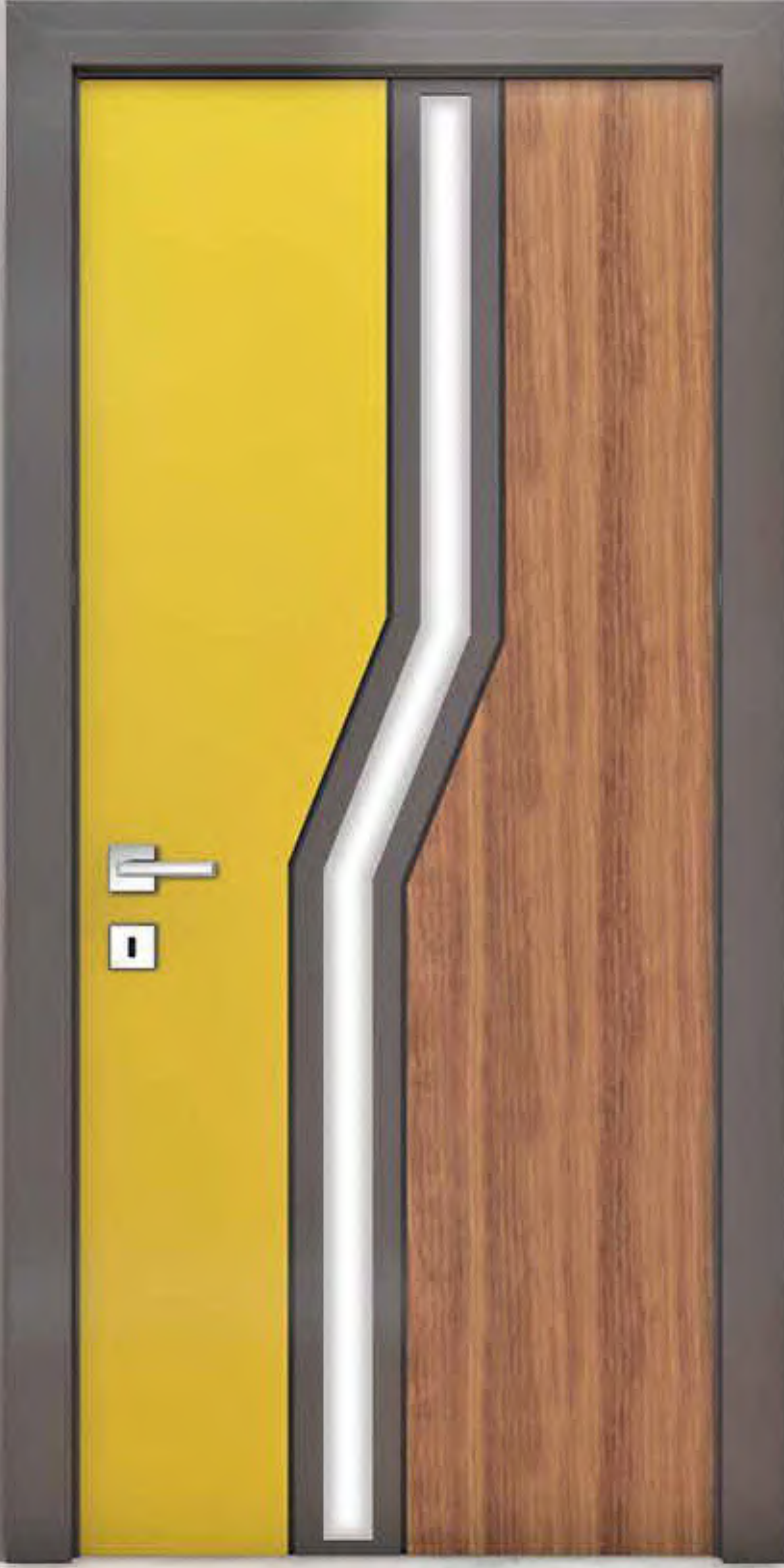

Ely

HM-037

Exclusive Lake Yüzey
Exclusive Lacquer Surface



Antra HM-038

Exclusive Lake Yüzey
Exclusive Lacquer Surface

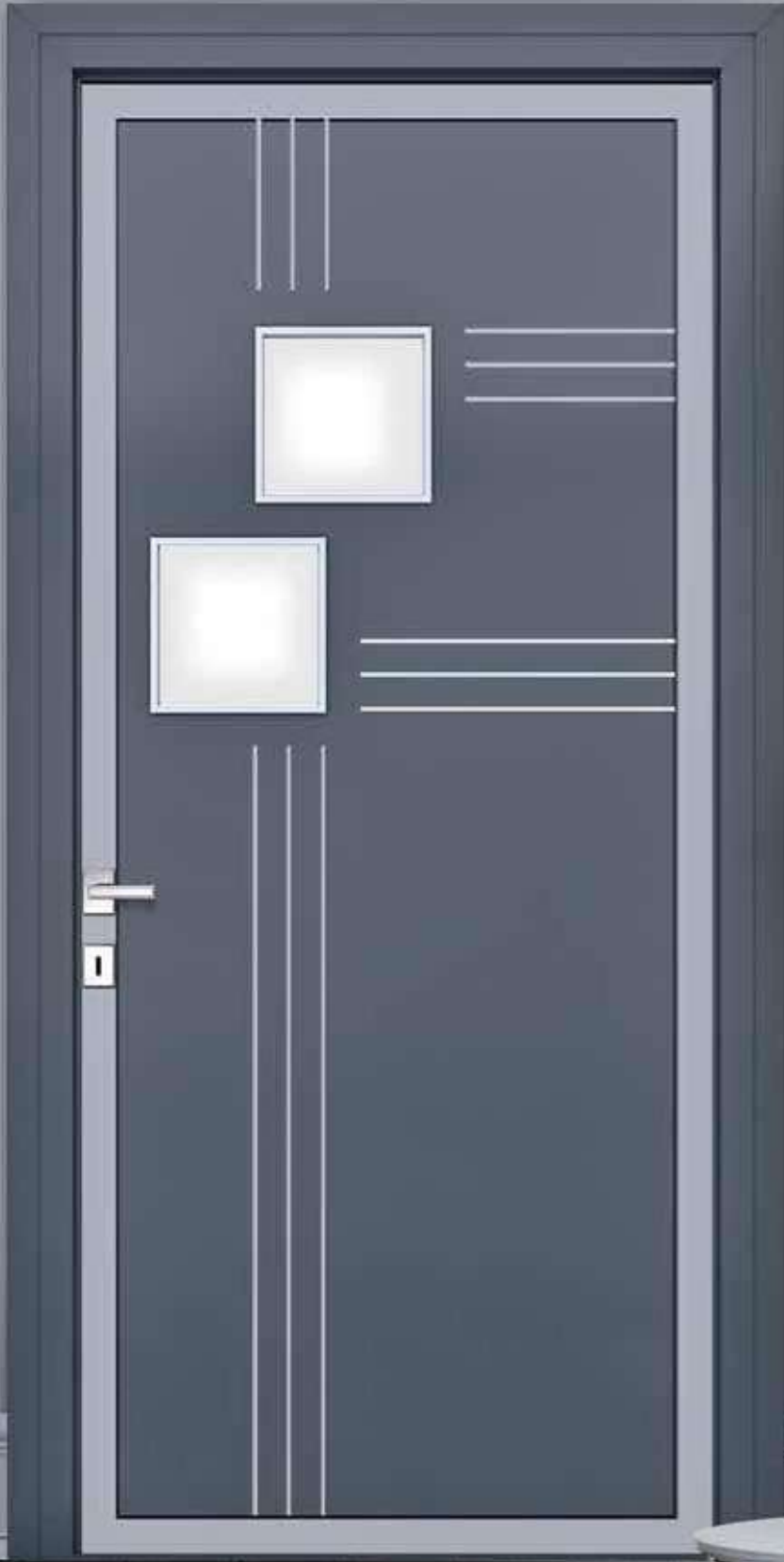



Arel

HM-039

Exclusive Lake Yüzey
Exclusive Lacquer Surface



Orange

HM-040

Exclusive Lake Yüzey
Exclusive Lacquer Surface

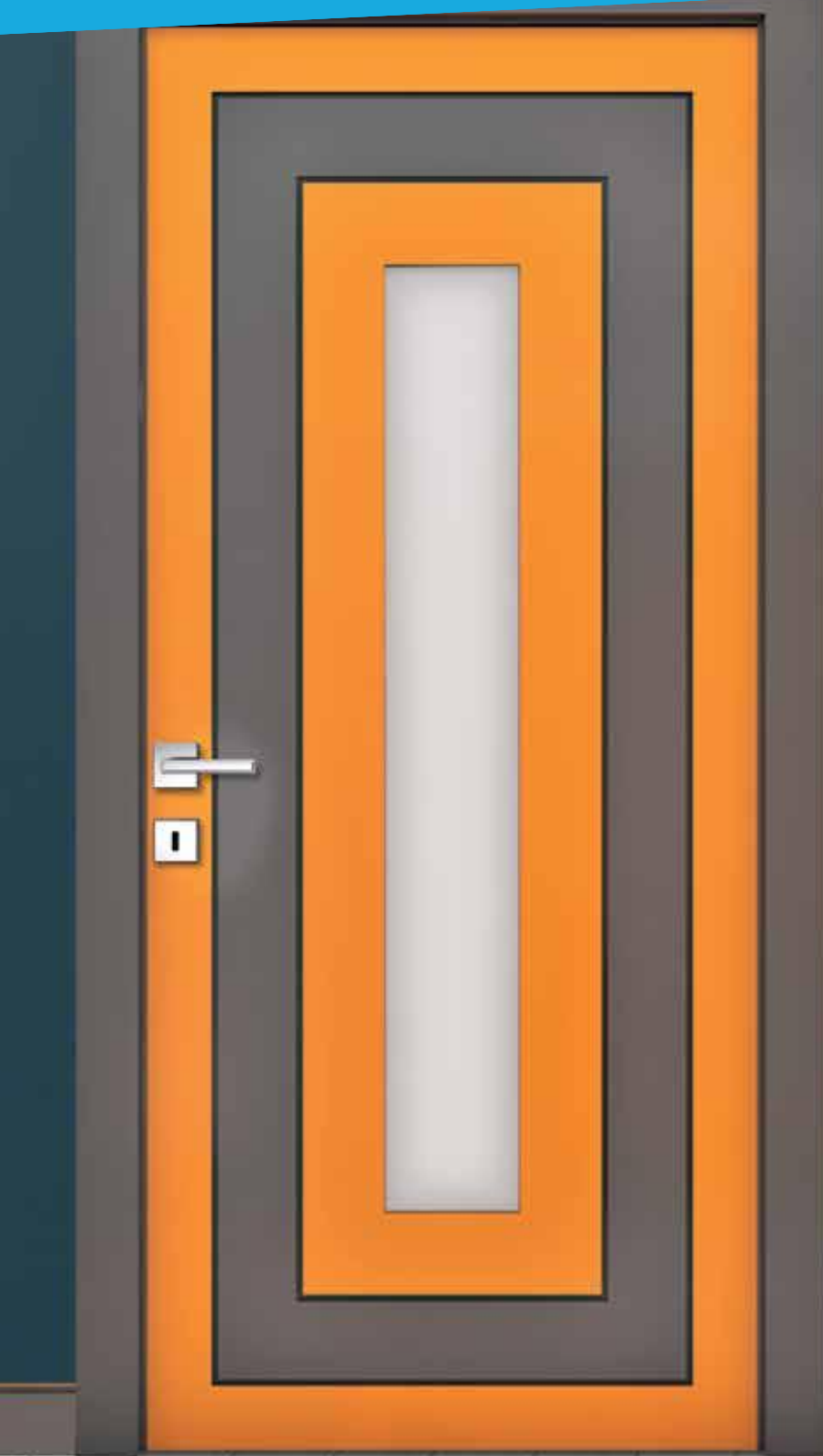

Armes

HM-041

Exclusive Lake Yüzey
Exclusive Lacquer Surface



Hefe

HM-042

Exclusive Lake Yüzey
Exclusive Lacquer Surface



Arles

HM-043

Exclusive Lake Yüzey
Exclusive Lacquer Surface



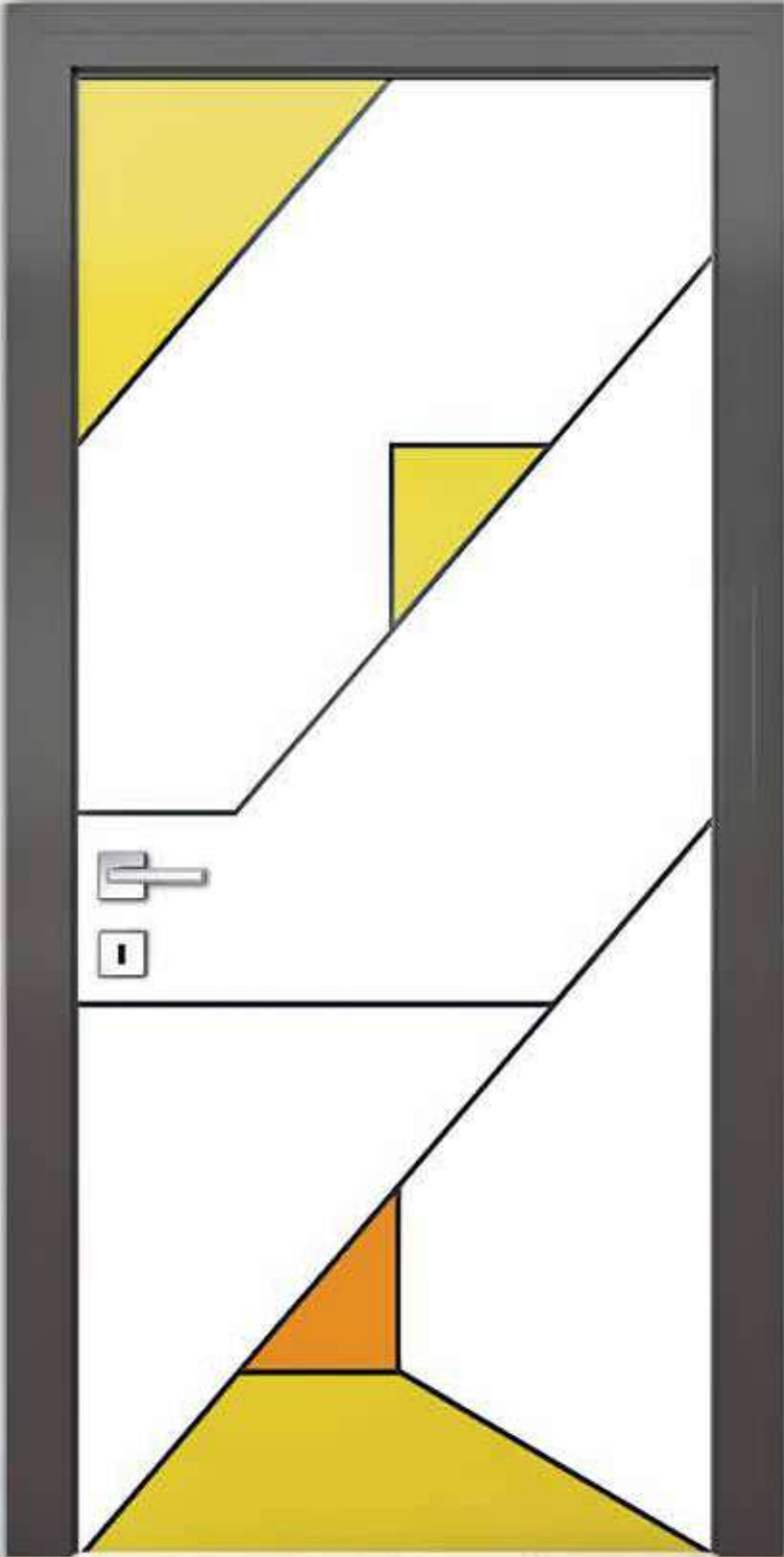

Puzzle

HM-044

Exclusive Lake Yüzey
Exclusive Lacquer Surface





Mürdüm HM-045

Exclusive Lake Yüzey
Exclusive Lacquer Surface



Pine

HM-046

Kurumsal Kapılar
Institution Doors

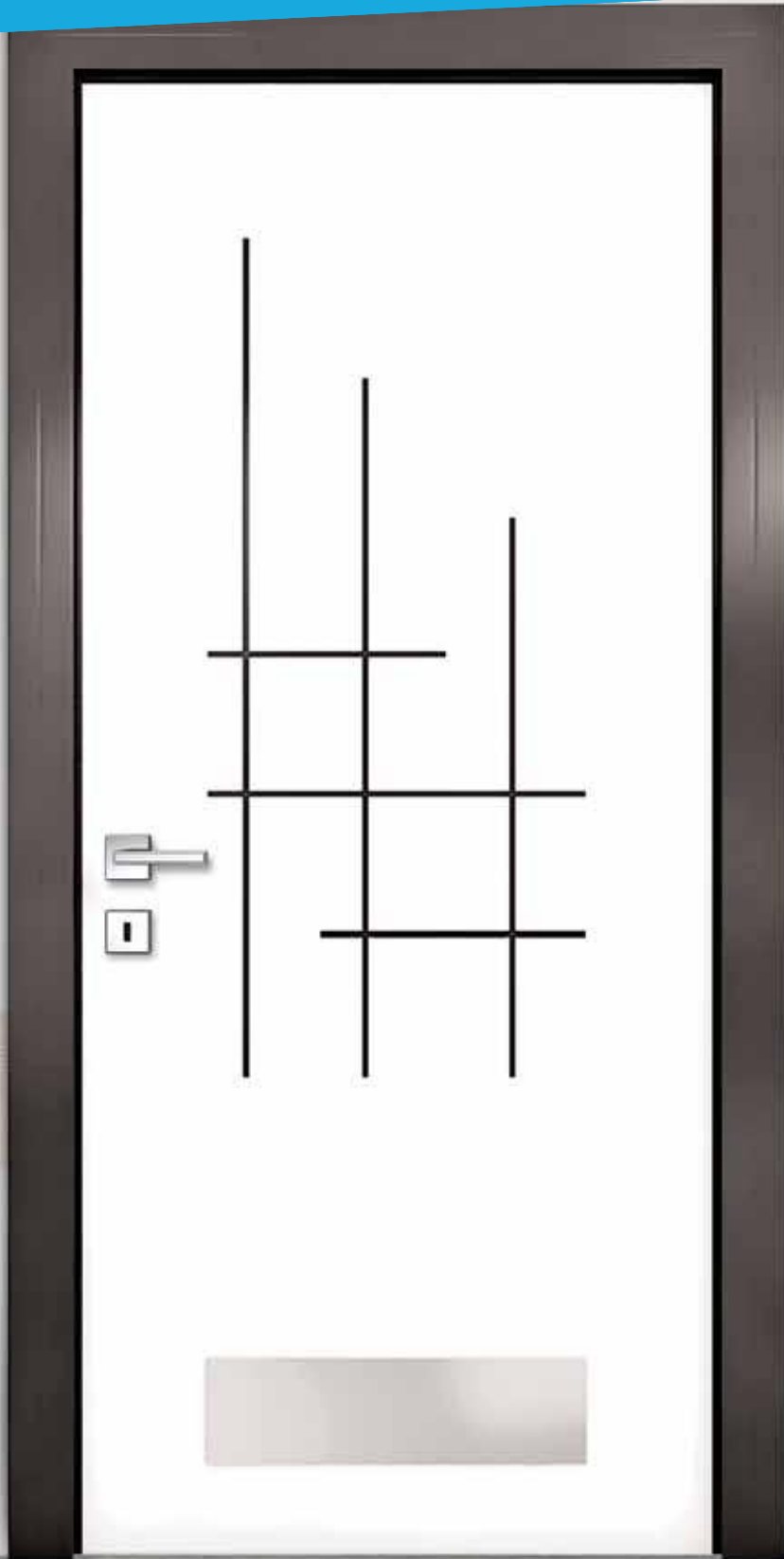

Agra

HM-047

Kurumsal Kapılar
Institution Doors



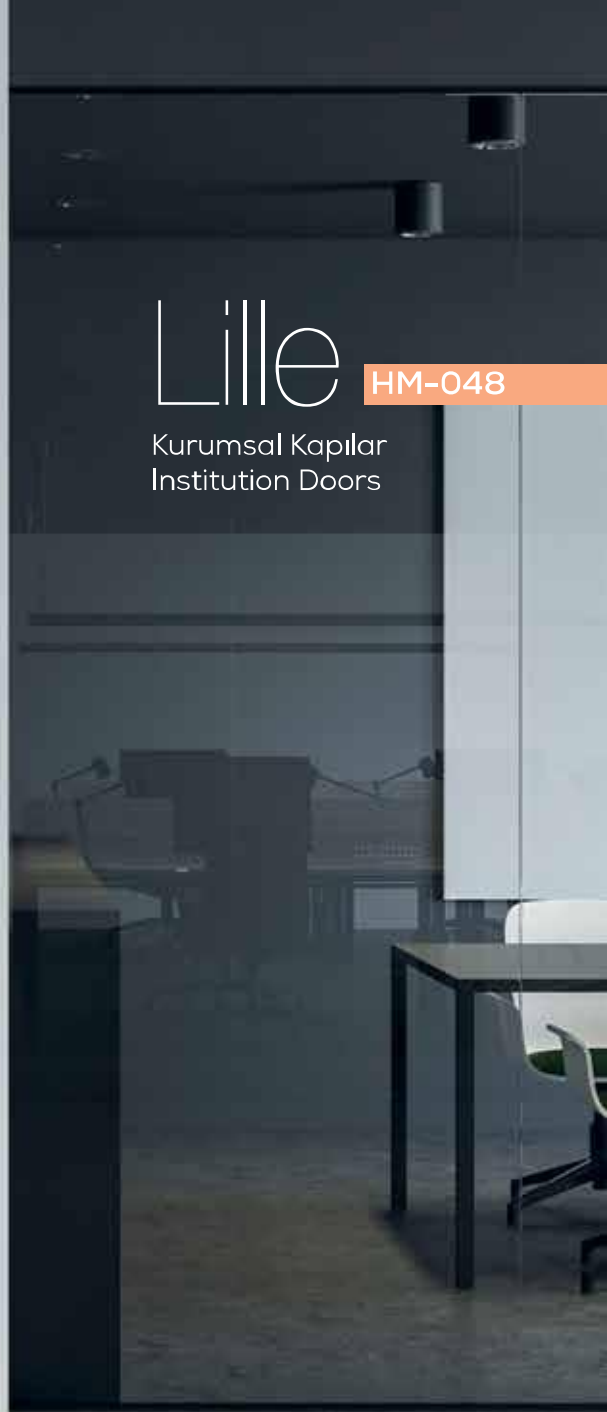

Lille

HM-048

Kurumsal Kapılar
Institution Doors

Roma

HM-049

Kurumsal Kapılar
Institution Doors

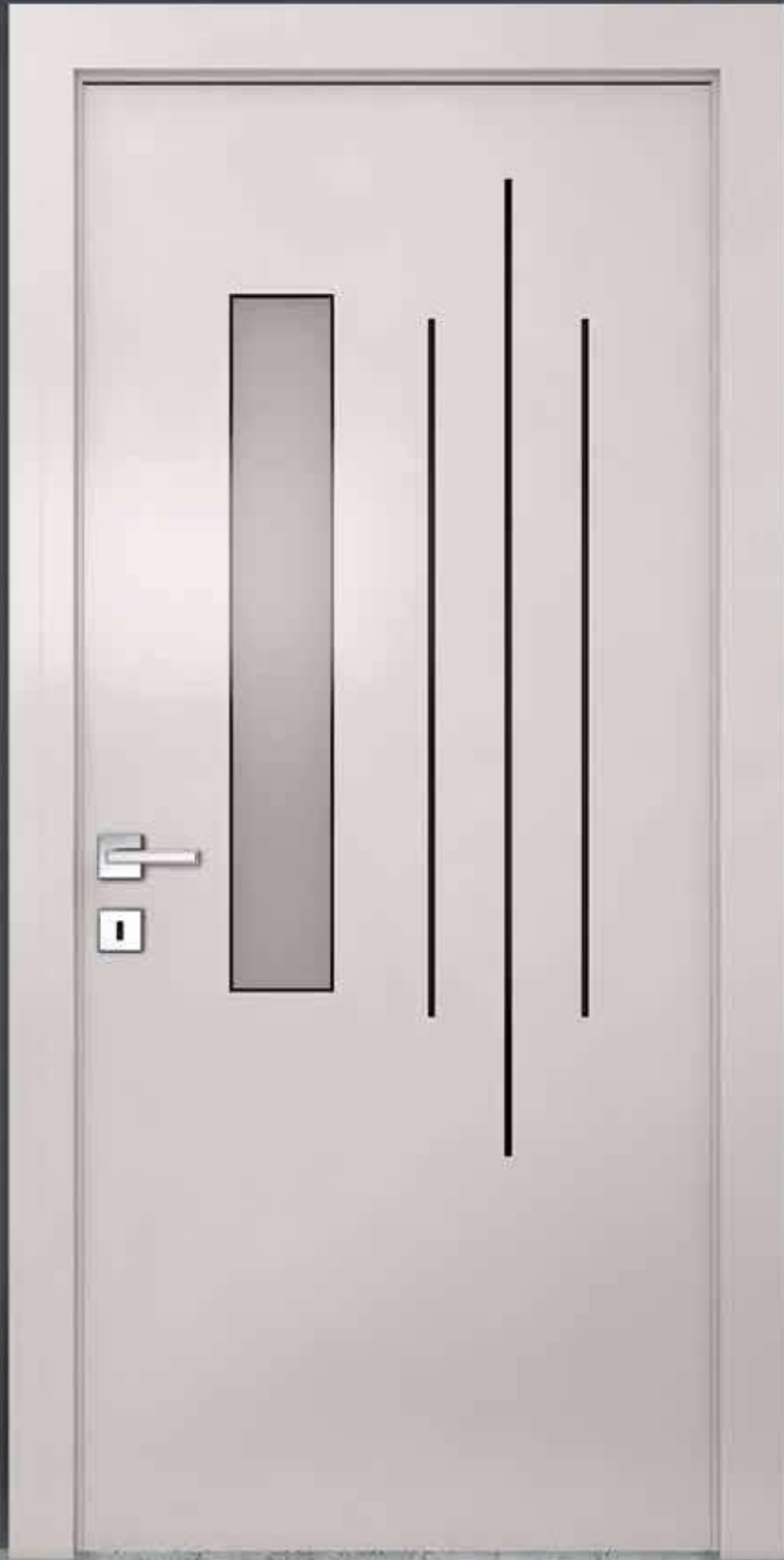

Vegas

HM-050

Kurumsal Kapılar
Institution Doors





Avrasia

Complementary Materials



FILEXIBLE SIPHONS

Code - 1100

65*32 Flexible siphon with inseperable head

65 mm 430 Grade Trap. 1/4"65 mm Screw 1^{1/4} - Throat Connection, Ø32 mm Bleeder



Pieces In Box	Package Size	Box Weight
125 Pcs	460 x 570 x450 mm	15 Kg



Code - 1101

65*40 Flexible siphon with inseperable head

65 mm 430 Grade Trap. 1/4"65 mm Screw 1^{1/4} - Throat Connection, Ø40 mm Bleeder

Pieces In Box	Package Size	Box Weight
125 Pcs	460 x 570 x450 mm	15 Kg

Code - 1102

65*50 Flexible siphon with inseperable head

65 mm 430 Grade Trap. 1/4"65 mm Screw 1^{1/4} - Throat Connection, Ø50 mm Bleeder

Pieces In Box	Package Size	Box Weight
100 Pcs	460 x 570 x450 mm	13 Kg



Code - 1103

65*32 Flexible siphon with inseperable head with W.M connection

65 mm 430 Grade Trap. 1/4"65 mm Screw 1^{1/4} - Throat Connection, Machine Connection

Pieces In Box	Package Size	Box Weight
125 Pcs	460 x 570 x450 mm	16 Kg



Code - 1104

65*32 Flexible siphon with inseperable head (stainless steel)

65 mm 304 Grade Inox Trap. 1/4"65 mm Screw 1^{1/4} - Throat Connection, Ø50 mm Bleeder

Pieces In Box	Package Size	Box Weight
125 Pcs	460 x 570 x450 mm	15 Kg

FILEXIBLE SIPHONS

Code - 1105

65*40 Flexible siphon with inseperable head (stainless steel)

65 mm 304 Grade Inox Trap. 1/4"65 mm Inox Screw. 1 1/4" - Throat Connection, Ø40 mm Bleeder

Pieces In Box	Package Size	Box Weight
125 Pcs	460 x 570 x450 mm	15 Kg

Code - 1106

65*50 Flexible siphon with inseperable head (stainless steel)

65 mm 304 Grade Inox Trap. 1/4"65 mm Inox Screw 1 1/4" - Throat Connection, Ø50 mm Bleeder

Pieces In Box	Package Size	Box Weight
100 Pcs	460 x 570 x450 mm	15 Kg

Code - 1107

85*32 Flexible siphon with inseperable head

85 mm 304 Grade Inox Trap. 1/4"65 mm Inox Screw 1 1/4" - Throat Connection, Ø32 mm Bleeder

Pieces In Box	Package Size	Box Weight
100 Pcs	460 x 570 x450 mm	14 Kg

Code - 1108

85*40 Flexible siphon with inseperable head (stainless steel)

85 mm 304 Grade Inox Trap. 1/4"65 mm Inox Screw 1 1/4" - Throat Connection, Machine Connection, Ø50 mm Bleeder

Pieces In Box	Package Size	Box Weight
100 Pcs	460 x 570 x450 mm	14 Kg

Code - 1104

85*50 Flexible siphon with inseperable head (stainless steel)

85 mm 304 Grade Inox Trap. 1/4"65 mm Screw 1 1/4" - Throat Connection, Ø50 mm Bleeder

Pieces In Box	Package Size	Box Weight
90 Pcs	460 x 570 x450 mm	14 Kg

FILEXIBLE SIPHONS





Code - 1110

65*32 Long Flexible siphon with inseperable head

65 mm 430 Grade Trap. 1/4"65 mm Screw 1 1/4" - Throat Connection, Ø32 mm Bleeder. 145 cm

Pieces In Box	Package Size	Box Weight
100 Pcs	460 x 570 x450 mm	17 Kg

Code - 1111

70*32 Long Flexible siphon with inseperable head

70 mm 430 Grade Trap. 1/4"65 mm Screw 1 1/4" - Throat Connection, Ø32 mm Bleeder, 145 cm

Pieces In Box	Package Size	Box Weight
90 Pcs	460 x 570 x450 mm	17 Kg









Code - 1112

85*32 Long Flexible siphon with inseperable head

85 mm 430 Grade Trap. 1/4"65 mm Screw 1 1/4" - Throat Connection, Ø32 mm Bleeder, 145 cm

Pieces In Box	Package Size	Box Weight
90 Pcs	460 x 570 x450 mm	17 Kg

Code - 1113

65*32 Long Flexible siphon with inseperable head (stainless steel)

65 mm 304 Grade Inox Trap. 1/4"65 mm Screw 1 1/4" - Throat Connection, 32 mm Bleeder , 145 cm

Pieces In Box	Package Size	Box Weight
100 Pcs	460 x 570 x450 mm	17 Kg









Code - 1114

70*32 Long Flexible siphon with inseperable head (stainless steel)

70 mm 304 Grade Inox Trap. 1/4"65 mm Screw 1 1/4" - Throat Connection, Ø32 mm Bleeder, 145 cm

Pieces In Box	Package Size	Box Weight
90 Pcs	460 x 570 x450 mm	17 Kg

FILEXIBLE SIPHONS

Code - 1115

85*32 Long Flexible siphon with inseperable head (stainless steel)

85 mm 304 Grade Trap. 1/4"65 mm Screw 1 1/4 - Throat Connection, Ø32 mm Bleeder, 145 cm

Pieces In Box	Package Size	Box Weight
80 Pcs	460 x 570 x450 mm	17 Kg

Code - 1200

65*32 Luxury Flexible siphon with seperable head (stainless steel)

65 mm 304 Grade Trap. 1/4"65 mm Screw 1 1/4 - Throat Connection Nut, Ø40 mm Bleeder

Pieces In Box	Package Size	Box Weight
100 Pcs	460 x 570 x450 mm	14 Kg

Code - 1201

65*40 Luxury Flexible siphon with seperable head (stainless steel)

65 mm 304 Grade Trap. 1/4"65 mm Screw 1 1/4 - Throat Connection Nut, Ø40 mm Bleeder

Pieces In Box	Package Size	Box Weight
100 Pcs	460 x 570 x450 mm	15 Kg

Code - 1202

65*50 Luxury Flexible siphon with seperable head (stainless steel)

65 mm 304 Grade Trap. 1/4"65 mm Screw 1 1/4 - Throat Connection Nut , 50 mm Bleeder

Pieces In Box	Package Size	Box Weight
100 Pcs	460 x 570 x450 mm	15 Kg

Code - 1203

65*32 Luxury Flexible siphon with seperable head and W.M. connection (stainless steel)

65 mm 304 Grade Trap. 1/4"65 mm Screw 1 1/4 - Throat Connection Nut, Machine Connection

Pieces In Box	Package Size	Box Weight
100 Pcs	460 x 570 x450 mm	15 Kg

FILEXIBLE SIPHONS

Code - 1204



65*32 Luxury Flexible siphon with seperable head and double W.M. connection (stainless steel)

65 mm 304 Grade Trap. 1/4"65 mm Screw 1 1/4" - Throat Connection Nut, Double Machine Connection

Pieces In Box	Package Size	Box Weight
100 Pcs	460 x 570 x 450 mm	16 Kg

Code - 1205

70*32 Luxury Flexible siphon with seperable head (stainless steel)

70 mm 304 Grade Trap. 1/4"65 mm Screw 1 1/4" - Throat Connection Nut, Ø32 mm Bleeder



Pieces In Box	Package Size	Box Weight
100 Pcs	460 x 570 x 450 mm	16 Kg

Code - 1206



70*40 Luxury Flexible siphon with seperable head (stainless steel)



70 mm 304 Grade Trap. 1/4"65 mm Screw 1 1/4" - Throat Connection Nut, Ø40 mm Bleeder

Pieces In Box	Package Size	Box Weight
100 Pcs	460 x 570 x 450 mm	16 Kg

Code - 1207

70*50 Luxury Flexible siphon with seperable head (stainless steel)

70 mm 304 Grade Trap. 1/4"65 mm Screw 1 1/4" - Throat Connection Nut, 50 mm Bleeder

Pieces In Box	Package Size	Box Weight
100 Pcs	460 x 570 x 450 mm	16 Kg

Code - 1208



85*32 Luxury Flexible siphon with seperable head (stainless steel)

85 mm 304 Grade Trap. 1/4"65 mm Screw 1 1/4" - Throat Connection Nut, Ø32 mm Bleeder

Pieces In Box	Package Size	Box Weight
100 Pcs	460 x 570 x 450 mm	17 Kg

FILEXIBLE SIPHONS

Code - 1209

85*40 Luxury Flexible siphon with seperable head (stainless steel)

85 mm 304 Grade Trap, 1/4"65 mm Screw 1^{1/4} - Throat Connection Nut, Ø40 mm Bleeder

Pieces In Box	Package Size	Box Weight
90 Pcs	460 x 570 x450 mm	16 Kg

Code - 1210

85*50 Luxury Flexible siphon with seperable head (stainless steel)

85 mm 304 Grade Trap, 1/4"65 mm Screw 1^{1/4} - Throat Connection Nut, Ø50 mm Bleeder

Pieces In Box	Package Size	Box Weight
90 Pcs	460 x 570 x450 mm	16 Kg

Code - 1211

65*32 Luxury Flexible siphon with seperable head (stainless steel)

65 mm 304 Grade Trap, 1/4"65 mm Screw 1^{1/4} - Throat Connection Nut, Ø32 mm Bleeder, 145 cm

Pieces In Box	Package Size	Box Weight
90 Pcs	460 x 570 x450 mm	17 Kg

Code - 1212

70*32 Luxury Flexible siphon with seperable head (stainless steel)

70 mm 304 Grade Trap, 1/4"65 mm Screw 1^{1/4} - Throat Connection Nut, 32 mm Bleeder, 145 cm

Pieces In Box	Package Size	Box Weight
90 Pcs	460 x 570 x450 mm	17 Kg

Code - 1213

85*32 Luxury Flexible siphon with seperable head (stainless steel)

85 mm 304 Grade Inox Trap, 1/4"65 mm Screw 1^{1/4} - Throat Connection Nut, Ø32 mm Bleeder, 145 cm

Pieces In Box	Package Size	Box Weight
80 Pcs	460 x 570 x450 mm	16 Kg

FILEXIBLE SIPHONS

Code - 1214



65*32 Luxury Flexible siphon with seperable two heads (stainless steel)

65 mm 304 Grade Trap, 1/4"65 mm Screw 1 1/4" - Throat Connection Nut, Ø32 mm Bleeder

Pieces In Box	Package Size	Box Weight
40 Pcs	460 x 570 x450 mm	18 Kg

Code - 1215



70*32 Luxury Triple Flexible siphon with seperable two heads (stainless steel)

70 mm 304 Grade Trap, 1/4"65 mm Screw 1 1/4" - Throat Connection Nut, Ø32 mm Bleeder

Pieces In Box	Package Size	Box Weight
40 Pcs	460 x 570 x450 mm	18 Kg

Code - 1216



85*32 Luxury Triple Flexible siphon with seperable two heads (stainless steel)

85 mm 304 Grade Trap, 1/4"65 mm Screw 1 1/4" - Throat Connection Nut , Ø32 mm Bleeder

Pieces In Box	Package Size	Box Weight
40 Pcs	460 x 570 x450 mm	18 Kg

Code - 1217

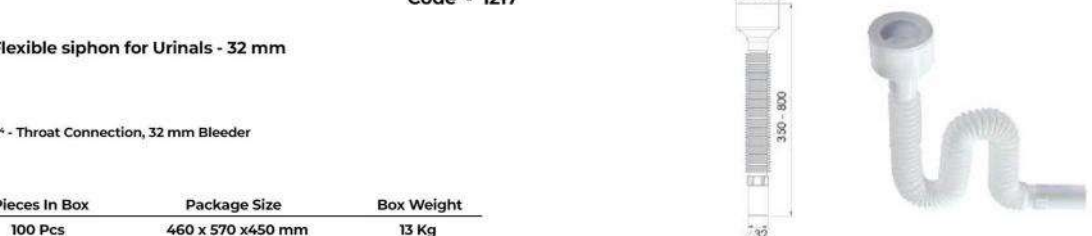

Flexible siphon for Urinals - 32 mm

1 1/4" - Throat Connection, 32 mm Bleeder

Pieces In Box	Package Size	Box Weight
100 Pcs	460 x 570 x450 mm	13 Kg

Code - 1218



Flexible siphon for Urinals - 50 mm

1 1/4" - Throat Connection, Ø50 mm Bleeder

Pieces In Box	Package Size	Box Weight
90 Pcs	460 x 570 x450 mm	13 Kg

BOTTLE TRAP SIPHONS

Code - 1300

Siphon with bottle and pipe for Urinals - 32 mm

1 1/4" - Throat Connection, Ø32 mm Bleeder

Pieces In Box	Package Size	Box Weight
75 Pcs	430 x 600 x 410 mm	15 Kg

Code - 1301

Flexible Siphon with bottle for Urinals - 32 mm

1 1/4" - Throat Connection, Ø32 mm Bleeder

Pieces In Box	Package Size	Box Weight
60 Pcs	430 x 600 x 410 mm	13 Kg

Code - 1302

Bottle siphon with pipe 1 1/4 - 32 mm

65 mm 304 Grade Inox Trap, 1/4" 65 mm Inox Screw 1 1/4" - Throat Connection Nut, Ø32 mm Bleeder

Pieces In Box	Package Size	Box Weight
75 Pcs	430 x 600 x 410 mm	13 Kg

Code - 1303

Bottle siphon with pipe and W.M. Connection 1 1/4 - 32 mm

65 mm 304 Grade Inox Trap, 1/4" 65 mm Inox Screw 1 1/4" - Throat Connection Nut, Machine Connection

Pieces In Box	Package Size	Box Weight
60 Pcs	430 x 600 x 410 mm	12 Kg

BOTTLE TRAP SIPHONS



Code - 1304

Siphon with Bootle and flexible pipe 1 1/4 - 32 mm

65 mm 304 Grade Inox Trap. 1/4"65 mm Inox Screw 1^{1/4} - Throat Connection Nut , Ø32 mm Bleeder

Pieces In Box	Package Size	Box Weight
60 Pcs	430 x 600 x410 mm	12 Kg

Code - 1305

Siphon with Bootle and flexible pipe 1 1/4 - 50 mm

65 mm 304 Grade Inox Trap. 1/4"65 mm Inox Screw 1^{1/4} - Throat Connection Nut , Ø50 mm Bleeder

Pieces In Box	Package Size	Box Weight
60 Pcs	430 x 600 x410 mm	13 Kg





Code - 1306

Bottle Siphon with flexible pipe and W.M. Connection 1 1/4 - 32 mm

65 mm 304 Grade Inox Trap. 1/4"65 mm Inox Screw 1^{1/4} - Throat Connection Nut , Ø32 mm Bleeder

Pieces In Box	Package Size	Box Weight
60 Pcs	430 x 600 x410 mm	12 Kg

Code - 1307

Bottle Siphon with flexible pipe and double W.M. Connection 1 1/4 - 32 mm

65 mm 304 Grade Inox Trap. 1/4"65 mm Inox Screw 1^{1/4} - Throat Connection Nut , Ø32 mm Bleeder
Double Machine Connection

Pieces In Box	Package Size	Box Weight
60 Pcs	430 x 600 x410 mm	12 Kg



BOTTLE TRAP SIPHONS



Code - 1308

Bottle siphon with pipe 1/2 - 40 mm

65 mm 304 Grade Inox Trap, 1/4"65 mm Inox Screw 1 1/4" - Throat Connection Nut, Ø40 mm Bleeder

Pieces In Box	Package Size	Box Weight
60 Pcs	430 x 600 x410 mm	12 Kg

Code - 1309

Bottle siphon with flexible pipe 1/2 - 32 mm

65 mm 304 Grade Inox Trap, 1/4"65 mm Inox Screw 1 1/4" - Throat Connection Nut, Ø32 mm Bleeder

Pieces In Box	Package Size	Box Weight
60 Pcs	430 x 600 x410 mm	12 Kg





Code - 1310

Big head bottle siphon with flexible pipe and stopper 1/2 - 40-50 mm

65 mm 304 Grade Inox Trap, 1/4"65 mm Inox Screw 1 1/4" - Throat Connection Nut, Ø50 mm Bleeder

Pieces In Box	Package Size	Box Weight
60 Pcs	430 x 600 x410 mm	13 Kg

Code - 1311

Big head bottle siphon with flexible pipe and flow 1/2 - 40-50 mm

65 mm 304 Grade Inox Trap, 1/4"65 mm Inox Screw 1 1/4" - Throat Connection Nut, Ø50 mm Bleeder

Pieces In Box	Package Size	Box Weight
60 Pcs	430 x 600 x410 mm	12 Kg



S - SIPHONS

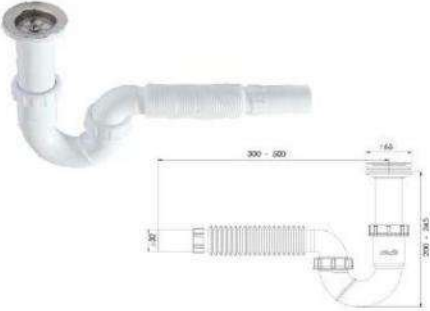

Code - 1312

"S" shape siphon with flexible pipe 1 1/2 - 32 mm

65 mm 304 Grade Inox Trap. 1/4"65 mm Inox Screw 1 1/4 - Throat Connection Nut, Ø32 mm Bleeder

Pieces In Box	Package Size	Box Weight
60 Pcs	430 x 600 x 410 mm	12 Kg

Code - 1313

"S" shape siphon with flexible pipe 1 1/2 - 50 mm

65 mm 304 Grade Inox Trap. 1/4"65 mm Inox Screw 1 1/4 - Throat Connection Nut, Ø50 mm Bleeder



Pieces In Box	Package Size	Box Weight
60 Pcs	430 x 600 x 410 mm	12 Kg



Code - 1314

"S" shape siphon with flexible pipe and W.M. connection 1 1/2 - 32 mm

65 mm 304 Grade Inox Trap. 1/4"65 mm Inox Screw 1 1/4 - Throat Connection Nut, Machine connection

Pieces In Box	Package Size	Box Weight
60 Pcs	430 x 600 x 410 mm	13 Kg

Code - 1315

"S" shape siphon for washbasin with pipe 1 1/2 - 32 mm

65 mm 304 Grade Inox Trap. 1/4"65 mm Inox Screw 1 1/4 - Throat Connection Nut, Ø32 mm Bleeder



Pieces In Box	Package Size	Box Weight
60 Pcs	430 x 600 x 410 mm	12 Kg

S- SIPHONS

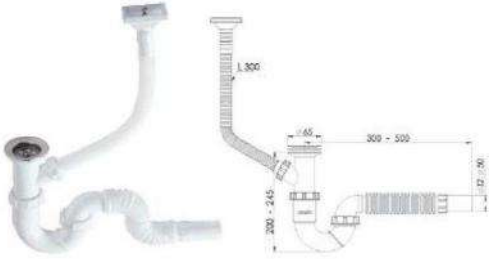

Code - 1316

"S" shape siphon with flow and flexible pipe 1 1/2 - 32-40 (vertical)

65 mm 304 Grade Inox Trap. 1/4"65 mm Inox Screw 1^{1/2} - Throat Connection Nut, Ø32 mm Bleeder, Vertical

Pieces In Box	Package Size	Box Weight
40 Pcs	430 x 600 x410 mm	12 Kg

Code - 1317

"S" shape siphon with flow and flexible pipe 1 1/2 - 32-40 (horizontal)

65 mm 304 Grade Inox Trap. 1/4"65 mm Inox Screw 1^{1/2} - Throat Connection Nut, Ø32 mm Bleeder, Horizontal

Pieces In Box	Package Size	Box Weight
40 Pcs	430 x 600 x410 mm	12 Kg

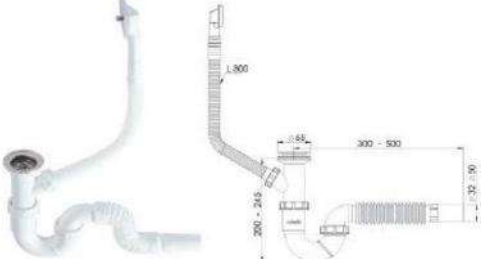

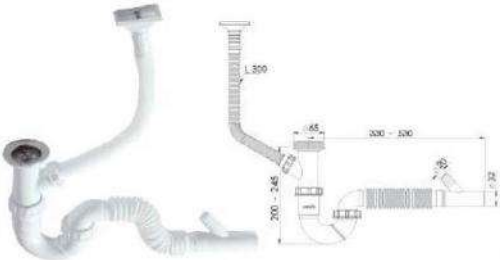

Code - 1318

"S" shape siphon with flow, flexible pipe and W.M. connection 1 1/2 - 32-40 (vertical)

65 mm 304 Grade Inox Trap. 1/4"65 mm Inox Screw 1^{1/2} - Throat Connection Nut, Machine Connection, Vertical

Pieces In Box	Package Size	Box Weight
40 Pcs	430 x 600 x410 mm	13 Kg

Code - 1319

"S" shape siphon with flow, flexible pipe and W.M. connection 1 1/2 - 32-40 (horizontal)

65 mm 304 Grade Inox Trap. 1/4"65 mm Inox Screw 1^{1/2} - Throat Connection Nut, Machine Connection, Horizontal

Pieces In Box	Package Size	Box Weight
40 Pcs	430 x 600 x410 mm	12 Kg

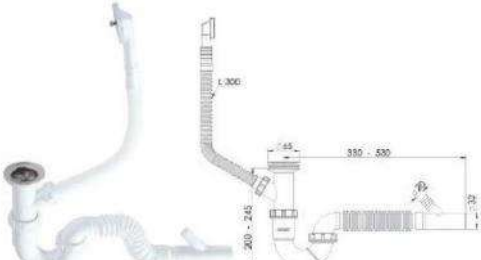

DOUBLE BOWL SINK SIPHONS

Code - 1320

"S" shape Siphon with double head, flexible pipe and flow 1 1/2 - 32-40 (vertical)

65 mm 304 Grade Inox Trap. 1/4"65 mm Inox Screw 1^{1/2} - Throat Connection Nut, Ø32 mm Bleeder, Vertical

Pieces In Box	Package Size	Box Weight
20 Pcs	430 x 600 x 410 mm	12 Kg

Code - 1321

"S" shape Siphon with double head, flexible pipe and flow 1 1/2 - 32-40 (horizontal)

65 mm 304 Grade Inox Trap. 1/4"65 mm Inox Screw 1^{1/2} - Throat Connection Nut, Ø32 mm Bleeder, Horizontal

Pieces In Box	Package Size	Box Weight
20 Pcs	430 x 600 x 410 mm	12 Kg

Code - 1322

"S" shape Siphon with double head, flexible pipe, flow and W.M. Connection 1 1/2 - 32-40 (vertical)

65 mm 304 Grade Inox Trap. 1/4"65 mm Inox Screw 1^{1/2} - Throat Connection Nut, Machine Connection, Vertical

Pieces In Box	Package Size	Box Weight
20 Pcs	430 x 600 x 410 mm	12 Kg

Code - 1323

"S" shape Siphon with double head, flexible pipe, flow and W.M. connection 1 1/2 - 32-40 (horizontal)

65 mm 304 Grade Inox Trap. 1/4"65 mm Inox Screw 1^{1/2} - Throat Connection Nut, Machine Connection, Horizontal

Pieces In Box	Package Size	Box Weight
20 Pcs	430 x 600 x 410 mm	12 Kg

BOTTLE TRAP SIPHONS

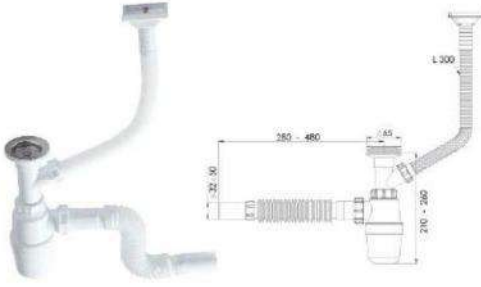

Code - 1324

Bottle siphon with flexible pipe and flow 1 1/4 - 32-40 (vertical)

65 mm 430 Grade Inox Trap. 1/4"65 mm Inox Screw 1^{1/4} - Throat Connection Nut, Ø32 mm Bleeder, Vertical

Pieces In Box	Package Size	Box Weight
40 Pcs	430 x 600 x 410 mm	12 Kg

Code - 1325

Bottle siphon with flexible pipe and flow 1 1/4 - 32-40 (horizontal)

65 mm 304 Grade Inox Trap. 1/4"65 mm Inox Screw 1^{1/4} - Throat Connection Nut, Ø32 mm Bleeder, Horizontal



Pieces In Box	Package Size	Box Weight
40 Pcs	430 x 600 x 410 mm	12 Kg



Code - 1326

Double Head Bottle siphon with flexible pipe and flow 1 1/4 - 32-40 (vertical)

65 mm 304 Grade Inox Trap. 1/4"65 mm Inox Screw 1^{1/4} - Throat Connection Nut, Ø32 mm Bleeder, Vertical

Pieces In Box	Package Size	Box Weight
20 Pcs	430 x 600 x 410 mm	12 Kg

Code - 1327

Double Head Bottle siphon with flexible pipe and flow 1 1/4 - 32-40 (horizontal)

65 mm 304 Grade Inox Trap. 1/4"65 mm Inox Screw 1^{1/4} - Throat Connection Nut, Ø32 mm Bleeder, Horizontal



Pieces In Box	Package Size	Box Weight
20 Pcs	430 x 600 x 410 mm	12 Kg

BOTTLE TRAP SIPHONS

Code - 1328

Double head bottle siphon with flexible pipe, flow and W.M. Connection 1 1/4 - 32-40 (vertical)

65 mm 304 Grade Inox Trap. 1/4" 65 mm Inox Screw 1^{1/4} - Throat Connection Nut, Machine Connection. Vertical

Pieces In Box	Package Size	Box Weight
20 Pcs	430 x 600 x 410 mm	12 Kg



Code - 1329

Double head bottle siphon with flexible pipe, flow and W.M. Connection 1 1/4 - 32-40 (horizontal)

65 mm 304 Grade Inox Trap. 1/4" 65 mm Inox Screw 1^{1/4} - Throat Connection Nut, Machine Connection. Horizontal

Pieces In Box	Package Size	Box Weight
20 Pcs	430 x 600 x 410 mm	12 Kg



3 1/2" DRAIN SIPHONS FOR SINGLE BOWL SINKS

Code - 1400

"S" Shape siphon with big head, flexible pipe, and stopper 1 1/2 - 32-40 (shallow)

110 mm 304 Grade Inox Small Shallow Trap, 1/4"65 mm Inox Screw 1^{1/2} - Throat Connection Nut, Ø32 mm Bleeder

Pieces In Box	Package Size	Box Weight
40 Pcs	430 x 600 x410 mm	12 Kg

Code - 1401

"S" Shape siphon with big head, flexible pipe, stopper W.M. connector 1 1/2 - 32-40 (shallow)

110 mm 304 Grade Inox Small Shallow Trap, 1/4"65 mm Inox Screw 1^{1/2} - Throat Connection Nut, Machine Connection

Pieces In Box	Package Size	Box Weight
40 Pcs	430 x 600 x410 mm	12 Kg

Code - 1402

"S" Shape siphon with big head, flexible pipe, and stopper 1 1/2 - 32-40 (shallow)

110 mm 304 Grade Inox Small Shallow Trap, 1/4"65 mm Inox Screw 1^{1/2} - Throat Connection Nut, Ø32 mm Bleeder, Vertical Overflowing Gauge

Pieces In Box	Package Size	Box Weight
25 Pcs	430 x 600 x410 mm	12 Kg

Code - 1403

"S" Shape siphon with big head, flexible pipe, flow and stopper 1 1/2 - 32-40 (horizontal - shallow)

110 mm 304 Grade Inox Small Shallow Trap, 1/4"65 mm Inox Screw 1^{1/2} - Throat Connection Nut, 32 mm Bleeder, Side Overflowing Gauge

Pieces In Box	Package Size	Box Weight
25 Pcs	430 x 600 x410 mm	12 Kg

3 1/2 DRAIN SIPHONS FOR SINGLE BOWL SINKS

Code - 1404

"S" shape siphon with big head, flexible pipe flow and, stopper and W.M.connection 1 1/2 - 32-40(vertical -shallow)

110 mm 304 Grade Inox Small Shallow Trap, 1/4"65 mm Inox Screw 1 1/2 - Throat Connection Nut, Machine Connection, Vertical Overflowing Gauge

Pieces In Box	Package Size	Box Weight
25 Pcs	430 x 600 x410 mm	12 Kg

Code - 1405

"S" shape siphon with big head, flexible pipe flow and, stopper and W.M.connection 1 1/2 - 32-40(horizontal -shallow)

110 mm 304 Grade Inox Small Shallow Trap, 1/4"65 mm Inox Screw 1 1/2 - Throat Connection Nut, Machine Connection, Side Overflowing Gauge

Pieces In Box	Package Size	Box Weight
25 Pcs	430 x 600 x410 mm	12 Kg

Code - 1406

Siphon with one big head and flexible pipe 1 1/2 - 32-40

110 mm 304 Grade Inox Small Shallow Trap, 1/4"65 mm Inox Screw 1 1/2 - Throat Connection Nut, 32 mm Bleeder

Pieces In Box	Package Size	Box Weight
50 Pcs	430 x 600 x410 mm	12 Kg

Code - 1407

Luxury double big head triple flexible siphon with stopper 1 1/2 - 32-40

110 mm 304 Grade Inox Small Shallow Trap, 1/4"65 mm Inox Screw 1 1/2 - Throat Connection Nut, 32 mm Bleeder

Pieces In Box	Package Size	Box Weight
20 Pcs	430 x 600 x410 mm	13 Kg

3 1/2" DRAIN SIPHONS FOR SINGLE BOWL SINKS

Code - 1408

"S" shape siphon with double big head, flexible pipe and stopper 1 1/2 - 32-50 (shallow)

110 mm 304 Grade Inox Small Shallow Trap. 1/4"65 mm Inox Screw 1 1/2 - Throat Connection Nut, Ø32 mm Bleeder

Pieces In Box	Package Size	Box Weight
15 Pcs	430 x 600 x 410 mm	12 Kg

Code - 1409

"S" shape siphon with double big head, flexible pipe and stopper W.M. 1 1/2 - 32-40 (shallow)

110 mm 304 Grade Inox Small Shallow Trap. 1/4"65 mm Inox Screw 1 1/2 - Throat Connection Nut, Machine Connection

Pieces In Box	Package Size	Box Weight
15 Pcs	430 x 600 x 410 mm	12 Kg

Code - 1410

"S" shape siphon with double big head, flexible pipe and stopper and flow 1 1/2 - 32-40 (shallow)

110 mm 304 Grade Inox Small Shallow Trap. 1/4"65 mm Inox Screw 1 1/2 - Throat Connection Nut, 32 mm Bleeder, Vertical Overflowing Gauge

Pieces In Box	Package Size	Box Weight
15 Pcs	430 x 600 x 410 mm	12 Kg

Code - 1411

"S" shape siphon with double big head, flexible pipe stopper and flow 1 1/2 - 32-40 (horizontal-shallow)

110 mm 304 Grade Inox Small Shallow Trap. 1/4"65 mm Inox Screw 1 1/2 - Throat Connection Nut, 32 mm Bleeder, Side Overflowing Gauge

Pieces In Box	Package Size	Box Weight
15 Pcs	430 x 600 x 410 mm	12 Kg

3 1/2" DRAIN SIPHONS FOR SINGLE BOWL SINKS



Code - 1412

"S" shape siphon with double big head, flexible pipe, stopper, flow and W.M. connection 1 1/2" - 32-50 (vertical-shallow)

110 mm 304 Grade Inox Small Shallow Trap, 1/4"65 mm Inox Screw 1 1/2" - Throat Connection Nut, Machine Connection, Vertical Overflowing Gauge

Pieces In Box	Package Size	Box Weight
15 Pcs	430 x 600 x 410 mm	12 Kg





Code - 1413

"S" shape siphon with double big head, flexible pipe, stopper, flow and W.M. connection 1 1/2" - 32-50 (horizontal-shallow)

110 mm 304 Grade Inox Small Shallow Trap, 1/4"65 mm Inox Screw 1 1/2" - Throat Connection Nut, Machine Connection, Side Overflowing Gauge

Pieces In Box	Package Size	Box Weight
15 Pcs	430 x 600 x 410 mm	12 Kg

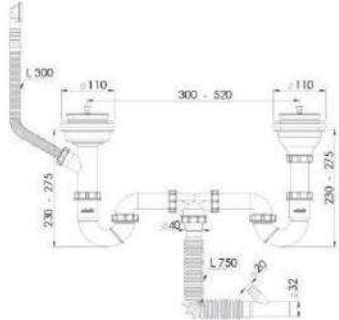

3 1/2" DRAIN SIPHONS FOR SINGLE BOWL SINKS

Code - 1500

"S" Shape siphon with one big head flexible pipe 1 1/2" - 32-50 (horizontal-deep)



110 mm 304 Grade Inox Big Deep Trap, 1/4"65 mm Inox Screw
1" - Throat Connection Nut, 832 mm Bleeder

Pieces In Box	Package Size	Box Weight
40 Pcs	430 x 600 x410 mm	12 Kg

Code - 1501

"S" Shape siphon with one big head flexible pipe and 1 1/2" - 32-50 (horizontal-deep)



110 mm 304 Grade Inox Big Deep Trap, 1/4"65 mm Inox Screw
1" - Throat Connection Nut, Machine Connection

Pieces In Box	Package Size	Box Weight
40 Pcs	430 x 600 x410 mm	12 Kg

Code - 1502

"S" Shape siphon with one big head flexible pipe and flow 1 1/2" - 32-50 (vertical-deep)



110 mm 304 Grade Inox Big Deep Trap, 1/4"65 mm Inox Screw
1" - Throat Connection Nut, 32 mm Bleeder, Vertical Overflowing Gauge

Pieces In Box	Package Size	Box Weight
25 Pcs	430 x 600 x410 mm	12 Kg

Code - 1503

"S" Shape siphon with one big head flexible pipe and flow 1 1/2" - 32-40 (horizontal-deep)



110 mm 304 Grade Inox Big Deep Trap, 1/4"65 mm Inox Screw
1" - Throat Connection Nut, 32 mm Bleeder, Vertical Overflowing Gauge

Pieces In Box	Package Size	Box Weight
25 Pcs	430 x 600 x410 mm	12 Kg

3 1/2" DRAIN SIPHONS FOR SINGLE BOWL SINKS



Code - 1504

"S" Shape siphon with one big head flexible pipe ,flow and W.M. connection 1 1/2" - 32-40 (vertical-deep)

110 mm 304 Grade Inox Big Deep Trap, 1/4"65 mm Inox Screw
1" - Throat Connection Nut, Machine Connection, Vertical Overflowing Gauge

Pieces In Box	Package Size	Box Weight
25 Pcs	430 x 600 x410 mm	12 Kg

Code - 1505

"S" Shape siphon with one big head flexible pipe ,flow and W.M. connection 1 1/2" - 32-40 (horizontal-deep)

110 mm 304 Grade Inox Small Shallow Trap, 1/4"65 mm Inox Screw
1" - Throat Connection Nut, Mac Con.

Pieces In Box	Package Size	Box Weight
25 Pcs	430 x 600 x410 mm	12 Kg





Code - 1506

"S" Shape siphon with one big head flexible pipe , 1 1/2" - 32-40 (deep)

110 mm 304 Grade Inox Big Deep Trap, 1/4"65 mm Inox Screw
1" - Throat Connection Nut, 32 mm Bleeder

Pieces In Box	Package Size	Box Weight
50 Pcs	430 x 600 x430 mm	12 Kg

Code - 1507

Luxury double big head triple flexible siphon , 1 1/2" - 32-40

110 mm 304 Grade Inox Big Deep Trap, 1/4"65 mm Inox Screw
1" - Throat Connection Nut, 32 mm Bleeder

Pieces In Box	Package Size	Box Weight
20 Pcs	430 x 600 x410 mm	15 Kg



3 1/2" DRAIN SIPHONS FOR SINGLE BOWL SINKS



Code - 1508

"S" Shape siphon with double big head with double pipe and flexible pipe 32-50 (deep)

110 mm 304 Grade Inox Big Deep Trap, 1/4"65 mm Inox Screw
1" - Throat Connection Nut, 832 mm Bleeder

Pieces In Box	Package Size	Box Weight
15 Pcs	430 x 600 x 410 mm	15 Kg

Code - 1509

"S" Shape siphon with double big head with double pipe flexible pipe and W.M. Connection 32-50 (deep)

110 mm 304 Grade Inox Big Deep Trap, 1/4"65 mm Inox Screw
1" - Throat Connection Nut, Machine Connection

Pieces In Box	Package Size	Box Weight
15 Pcs	430 x 600 x 410 mm	12 Kg





Code - 1510

"S" Shape siphon with double big head with double pipe ,flexible pipe and flow 32-50 (vertical-deep)

110 mm 304 Grade Inox Big Deep Trap, 1/4"65 mm Inox Screw
1" - Throat Connection Nut, 832 mm Bleeder Vertical Overflowing Gauge

Pieces In Box	Package Size	Box Weight
15 Pcs	430 x 600 x 410 mm	12 Kg

Code - 1511

"S" Shape siphon with double big head with double pipe ,flexible pipe and flow 32-50 (horizontal-deep)

110 mm 304 Grade Inox Big Deep Trap, 1/4"65 mm Inox Screw
1" - Throat Connection Nut, 832 mm Bleeder Side Overflowing Gauge

Pieces In Box	Package Size	Box Weight
15 Pcs	430 x 600 x 410 mm	12 Kg



3 1/2" DRAIN SIPHONS FOR SINGLE BOWL SINKS

Code - 1512

"S" Shape siphon with double big head with double pipe, flexible pipe flow and W.M. connection 32-50 (vertical-deep)

110 mm 304 Grade Inox Big Deep Trap, 1/4"65 mm Inox Screw
1" - Throat Connection Nut, 832 mm Bleeder, Vertical Overflowing Gauge

Pieces In Box	Package Size	Box Weight
15 Pcs	430 x 600 x 410 mm	12 Kg

Code - 1513

"S" Shape siphon with double big head with double pipe, flexible pipe flow and W.M. connection 32-50 (horizontal-deep)

110 mm 304 Grade Inox Big Deep Trap, 1/4"65 mm Inox Screw
1" - Throat Connection Nut, 832 mm Bleeder, Side Overflowing Gauge

Pieces In Box	Package Size	Box Weight
15 Pcs	430 x 600 x 410 mm	12 Kg

SHOWER AND BATHTUB SIPHONS



Code - 2100

Pipe shape shower siphon with flexible pipe 32 mm

70 mm 304 Grade Inox Trap, 3/4"45 mm Inox Screw
1 1/2" - Throat Connection Nut, 832 mm Bleeder

Pieces in Box	Package Size	Box Weight
60 Pcs	430 x 600 x 410 mm	12 Kg

Code - 2101

Pipe shape shower siphon with flexible pipe 50 mm

70 mm 304 Grade Inox Trap, 3/4"45 mm Inox Screw
1 1/2" - Throat Connection Nut, 850 mm Bleeder

Pieces in Box	Package Size	Box Weight
60 Pcs	430 x 600 x 410 mm	12 Kg





Code - 2102

Bottle shower siphon with flexible pipe 32 mm

70 mm Chrome Cover 1 1/2" - Throat Connection Nut, 832 mm Bleeder

Pieces in Box	Package Size	Box Weight
60 Pcs	430 x 600 x 410 mm	12 Kg

Code - 2103

Bottle shower siphon with flexible pipe 50 mm

70 mm Chrome Cover 1 1/2" - Throat Connection Nut, 850 mm Bleeder

Pieces in Box	Package Size	Box Weight
60 Pcs	430 x 600 x 410 mm	12 Kg

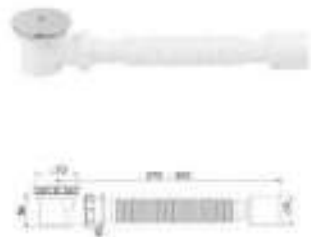

SHOWER AND BATHTUB SIPHONS

Code - 2104



Pipe Shape bathtub siphon with flexible pipe 32 mm

70 mm 304 Grade Inox Trap, 1/4" x 45 mm Inox Screw
1" - Throat Connection Nut, Ø32 mm Bleeder

Pieces In Box	Package Size	Box Weight
30 Pcs	430 x 600 x 400 mm	11 Kg

Code - 2105

Pipe Shape bathtub siphon with flexible pipe 50 mm

70 mm 304 Grade Inox Trap, 1/4" x 45 mm Inox Screw
1" - Throat Connection Nut, Ø50 mm Bleeder



Pieces In Box	Package Size	Box Weight
30 Pcs	430 x 600 x 400 mm	11 Kg

Code - 2106



Easy flex hose 35 mm

Ø50 mm Inlet, Ø40 - Ø50 mm Outlet, 35 cm

Pieces In Box	Package Size	Box Weight
200 Pcs	400 x 1100 x 670 mm	35 Kg

Code - 2107

Easy flex hose 45 mm

Ø50 mm Inlet, Ø40 - Ø50 mm Outlet, 50 cm



Pieces In Box	Package Size	Box Weight
150 Pcs	400 x 1100 x 670 mm	24 Kg

Code - 2108



Easy flex hose 60 mm

Ø50 mm Inlet, Ø40 - Ø50 mm Outlet, 60 cm

Pieces In Box	Package Size	Box Weight
100 Pcs	400 x 1100 x 670 mm	19 Kg

FILEXIBLE SIPHONS



Code - 3100

Toros toilet seat cover

PP Raw material, Plastic Hinge

Pieces In Box	Package Size	Box Weight
15 Pcs	470 x 370 x 800 mm	20 Kg

Code - 3101

Prestij ABS toilet seat cover

PP Raw material, Plastic Hinge



Pieces In Box	Package Size	Box Weight
15 Pcs	470 x 370 x 800 mm	17 Kg



Code - 3102

Galata toilet seat cover with metal hinges

PP Raw material, Metal Zinc Hinges

Pieces In Box	Package Size	Box Weight
10 Pcs	540 x 390 x 470 mm	19 Kg

FILEXIBLE SIPHONS



Code - 3103

Toros soft closer toilet seat cover

PP Raw material, Plastic Hinge

Pieces In Box	Package Size	Box Weight
10 Pcs	470 x 370 x 800 mm	16 Kg

Code - 3104

Galata soft closer toilet seat cover with metal hinges

PP Raw material, Metal Zinc Hinges



Pieces In Box	Package Size	Box Weight
10 Pcs	540 x 380 x 470 mm	19 Kg



Code - 3105

Square slim soft closer toilet seat cover with metal hinges

PP Raw material, Metal Hinge

Pieces In Box	Package Size	Box Weight
10 Pcs	540 x 390 x 470 mm	17 Kg

FILEXIBLE SIPHONS

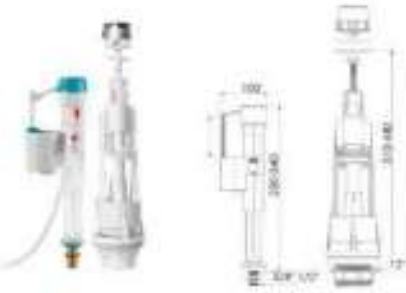

Code - 3110

3/8 brass inlet flash master float valve

Cistern Mechanism Single Push, Flash Master Floator Valve

Pieces In Box	Package Size	Box Weight
20 Pcs	590 x 710 x 330 mm	16 Kg

Code - 3111

3/8 brass inlet extra master float valve

Cistern Mechanism Single Push, Extra Master Floator Valve

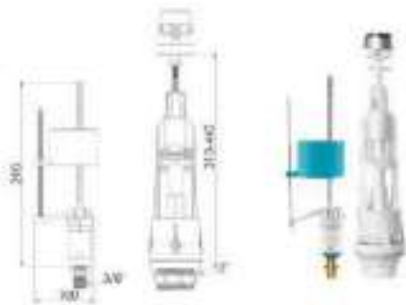

Pieces In Box	Package Size	Box Weight
20 Pcs	590 x 710 x 330 mm	15 Kg



Code - 3112

3/8 brass inlet telescopic master float valve

Below Side Brass Water Inlet Telescopic Floator Valve (3/8)

Pieces In Box	Package Size	Box Weight
50 Pcs	430 x 600 x 410 mm	14 Kg

Code - 3113

3/8 brass inlet master float valve

Below Side Brass Water Inlet Floator Valve (3/8)

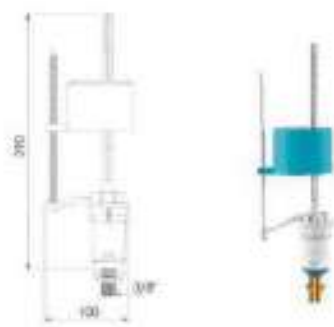

Pieces In Box	Package Size	Box Weight
50 Pcs	430 x 600 x 410 mm	9 Kg

FILEXIBLE SIPHONS

Code - 3106

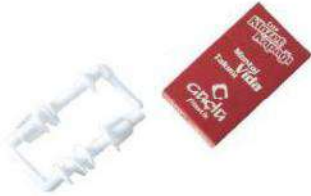

ABS Toilet seat cover plastic hinges

PP Raw Material

Pieces In Box	Package Size	Box Weight
200 Pcs	315 x 480 x 275 mm	10 Kg

Code - 3107

Toros Toilet seat cover plastic hinges

PP Raw Material

Pieces In Box	Package Size	Box Weight
200 Pcs	315 x 480 x 275 mm	10 Kg



Code - 3108



Upper screwing Toilet seat cover plastic hinges

Upper Screwing, PP Raw Material

Pieces In Box	Package Size	Box Weight
200 Pcs	315 x 480 x 275 mm	10 Kg

Code - 3109

Upper screwing Toilet seat cover metal hinges

Metal Zinc Upper Hinge

Pieces In Box	Package Size	Box Weight
200 Pcs	315 x 480 x 275 mm	10 Kg



FILEXIBLE SIPHONS

Code - 4100

WC - Pan connector with flexible pipe - 35 cm

Raw Material , Ø100, With Steel Wire

Pieces In Box	Package Size	Box Weight
40 Pcs	700 x 270 x 580 mm	14 Kg

Code - 4101

WC - Pan connector with flexible pipe - 50 cm

Raw Material , Ø100, With Steel Wire

Pieces In Box	Package Size	Box Weight
32 Pcs	590 x 710 x 330 mm	13 Kg

Code - 4102

WC - Pan connector with flexible pipe - 80 cm

Raw Material , Ø100, With Steel Wire

Pieces In Box	Package Size	Box Weight
25 Pcs	590 x 710 x 330 mm	12 Kg

Code - 4103

WC - Elbow shape pan connector with flexible pipe - 46 cm

Raw Material , Ø100, With Steel Wire

Pieces In Box	Package Size	Box Weight
24 Pcs	700 x 270 x 580 mm	9 Kg

FILEXIBLE SIPHONS



Code - 4104

WC - Pan connector - (Eva)
Eva Raw Material

Pieces In Box	Package Size	Box Weight
60 Pcs	430 x 600 x 410 mm	12 Kg



Code - 4105

Adaptor gasket
TPE Material

Pieces In Box	Package Size	Box Weight
300 Pcs	460 x 750 x 180 mm	10 Kg



Code - 4106

Gasket For Toilet
TPE Material

Pieces In Box	Package Size	Box Weight
700 Pcs	320 x 490 x 430 mm	17 Kg



Code - 4107

Gasket For closet seat
TPE Material

Pieces In Box	Package Size	Box Weight
500 Pcs	320 x 490 x 430 mm	17 Kg



Code - 4108

Toilet seat fixing hinges
Extra Inox Trap

Pieces In Box	Package Size	Box Weight
200 Pcs	245 x 420 x 160 mm	8 Kg



Code - 4109

Washbasin fixing hinges - 12 cm
Extra Inox Trap 12 cm

Pieces In Box	Package Size	Box Weight
100 Pcs	245 x 420 x 160 mm	14 Kg

FILEXIBLE SIPHONS



Code - 4110

Washing machine inlet hose - 1.5 mt

1,5 Meter, GFR-30 Raw Material

Pieces In Box	Package Size	Box Weight
50 Pcs	430 x 600 x440 mm	14 Kg



Code - 4111

Washing machine inlet hose - 2 mt

2 Meter, GFR-30 Raw Material

Pieces In Box	Package Size	Box Weight
40 Pcs	320 x 500 x440 mm	14 Kg



Code - 4112

Washing machine inlet hose - 2.5 mt

2,5 Meter, GFR-30 Raw Material

Pieces In Box	Package Size	Box Weight
40 Pcs	320 x 500 x440 mm	17 Kg



Code - 4113

Washing machine inlet hose - 3 mt

3 Meter, GFR-30 Raw Material

Pieces In Box	Package Size	Box Weight
30 Pcs	320 x 500 x440 mm	15 Kg



Code - 4114

Washing machine inlet hose - 4 mt

4 Meter, GFR-30 Raw Material

Pieces In Box	Package Size	Box Weight
20 Pcs	320 x 500 x440 mm	13 Kg



Code - 4115

Washing machine inlet hose - 5 mt

5 Meter, GFR-30 Raw Material

Pieces In Box	Package Size	Box Weight
20 Pcs	320 x 500 x440 mm	15 Kg

FILEXIBLE SIPHONS



Code - 4116

Washing machine outlet hose - 1.5 mt

1,5 Meter, PP Raw Material

Pieces In Box	Package Size	Box Weight
100 Pcs	580 x 1650 x 150 mm	5 Kg



Code - 4117

Washing machine outlet hose - 2 mt

2 Meter, PP Raw Material

Pieces In Box	Package Size	Box Weight
100 Pcs	580 x 2050 x 150 mm	11 Kg



Code - 4118

Washing machine outlet hose - 3 mt

3 Meter, PP Raw Material

Pieces In Box	Package Size	Box Weight
50 Pcs	580 x 1650 x 150 mm	8 Kg



Code - 4119

Washing machine outlet flexible hose - 1,5 mt

1,5 Meter, With Flexible Pipe, PP Raw Material

Pieces In Box	Package Size	Box Weight
100 Pcs	610 x 560 x 150 mm	8 Kg



Code - 4120

Washing machine outlet flexible hose - 2 mt

2 Meter, With Flexible Pipe, PP Raw Material

Pieces In Box	Package Size	Box Weight
100 Pcs	610 x 770 x 160 mm	10 Kg



Code - 4121

Washing machine outlet flexible hose - 3 mt

3 Meter, With Flexible Pipe, PP Raw Material

Pieces In Box	Package Size	Box Weight
100 Pcs	610 x 1000 x 160 mm	14 Kg

FILEXIBLE SIPHONS

Code - 4122



Bas (reservuar) hose with gasket - 1,5 mt

1,5 Meter, PP Raw Material

Pieces In Box	Package Size	Box Weight
50 Pcs	230 x 1600 x 480 mm	8 Kg

Code - 4123

Bas (reservuar) hose with gasket - 3 mt

3 Meter, PP Raw Material



Pieces In Box	Package Size	Box Weight
25 Pcs	230 x 1600 x 480 mm	7 Kg

Code - 4124



WC matik single cover

Single Cover, PP Raw Material

Pieces In Box	Package Size	Box Weight
120 Pcs	510 x 520 x 405 mm	7 Kg

Code - 4125

WC matik double covers

Double Covers, PP Raw Material



Pieces In Box	Package Size	Box Weight
120 Pcs	510 x 520 x 405 mm	7 Kg

FILEXIBLE SIPHONS



Code - 4126

Plastic washing rod - 17 cm

Small, 17 cm

Pieces In Box	Package Size	Box Weight
650 Pcs	315 x 490 x 435 mm	14 Kg



Code - 4127

Plastic washing rod - 29 cm

Middle, 29 cm

Pieces In Box	Package Size	Box Weight
400 Pcs	315 x 490 x 435 mm	14 Kg



Code - 4128

Plastic washing rod - 34 cm

Long, 34 cm

Pieces In Box	Package Size	Box Weight
400 Pcs	315 x 490 x 435 mm	12 Kg



Code - 4129

Plastic washing rod with chrome nipple - 17 cm

Small, 17 cm, Chrom Nipple

Pieces In Box	Package Size	Box Weight
500 Pcs	315 x 490 x 435 mm	11 Kg



Code - 4130

Plastic washing rod with chrome nipple - 29 cm

Middle, 29 cm, Chrom Nipple

Pieces In Box	Package Size	Box Weight
400 Pcs	315 x 490 x 435 mm	12 Kg



Code - 4131

Plastic washing rod with chrome nipple - 34 cm

Long, 34 cm, Chrom Nipple

Pieces In Box	Package Size	Box Weight
400 Pcs	315 x 490 x 435 mm	13 Kg

FILEXIBLE SIPHONS



Code - 4132

Sewage Locked plastic check valve - Ø110

Pieces In Box	Package Size	Box Weight
15 Pcs	535 x 620 x 655 mm	15 Kg

Sewage Locked plastic check valve - Ø125

Code - 4133



Pieces In Box	Package Size	Box Weight
15 Pcs	535 x 620 x 655 mm	16 Kg



Code - 4134

Sewage Locked plastic check valve - Ø160

Pieces In Box	Package Size	Box Weight
6 Pcs	720 x 440 x 520 mm	10 Kg

Sewage Locked plastic check valve - Ø200

Code - 4135



Pieces In Box	Package Size	Box Weight
6 Pcs	720 x 440 x 520 mm	11 Kg

FILEXIBLE SIPHONS



Code - 4136

Sewage Locked stainless steel anti flooding check valve - 0110

Pieces In Box	Package Size	Box Weight
15 Pcs	535 x 620 x 655 mm	16 Kg

Code - 4137

Sewage Locked stainless steel anti flooding check valve - 0125



Pieces In Box	Package Size	Box Weight
15 Pcs	535 x 620 x 655 mm	17 Kg



Code - 4138

Sewage Locked stainless steel anti flooding check valve - 0160

Pieces In Box	Package Size	Box Weight
6 Pcs	720 x 440 x 520 mm	9 Kg

Code - 4139

Sewage Locked stainless steel anti flooding check valve - 0200



Pieces In Box	Package Size	Box Weight
6 Pcs	720 x 440 x 520 mm	10 Kg

FILEXIBLE SIPHONS

Code - 5100

10x10 Rotary floor drains with stainless steel grid, check valve and $\varnothing 50$ horizontal outlet

10x10, $\varnothing 50$ mm Rotary, PP Raw Material, 304 Grade Inox Checkvalve.

Pieces In Box	Package Size	Box Weight
60 Pcs	320 x 500 x 440 mm	13 Kg

Code - 5101

10x10 floor drains with stainless steel grid and $\varnothing 50$ vertical outlet

10x10, $\varnothing 50$ mm Outlet From Below Side, PP Raw Material, 304 Grade Inox.

Pieces In Box	Package Size	Box Weight
60 Pcs	320 x 500 x 440 mm	10 Kg

Code - 5102

10x10 Rotary floor drains with stainless steel grid and $\varnothing 50$ horizontal outlet

10x10, $\varnothing 50$ mm Rotary, PP Raw Material, 304 Grade Inox.

Pieces In Box	Package Size	Box Weight
70 Pcs	320 x 500 x 440 mm	12 Kg

Code - 5103

10x10 Rotary floor drains with stainless steel grid and $\varnothing 50$ vertical outlet

10x10, $\varnothing 50$ mm Outlet From Below Side, PP Raw Material, 304 Grade Inox.

Pieces In Box	Package Size	Box Weight
70 Pcs	320 x 500 x 440 mm	10 Kg

FILEXIBLE SIPHONS



Code - 5104

15x15 Rotary floor drains with stainless steel grid, check valve and Ø50 horizontal outlet

15x15, Ø50 mm Rotary, PP Raw Material, 304 Grade Inox Checkvalve, Cremaic Compatible

Pieces In Box	Package Size	Box Weight
40 Pcs	320 x 500 x440 mm	13 Kg

Code - 5105

15x15 Rotary floor drains with stainless steel grid, and Ø50 vertical outlet

15x15, Ø50 mm Outlet From Below Side, PP Raw Material, 304 Grade Inox , Cremaic Compatible

Pieces In Box	Package Size	Box Weight
35 Pcs	320 x 500 x440 mm	11 Kg



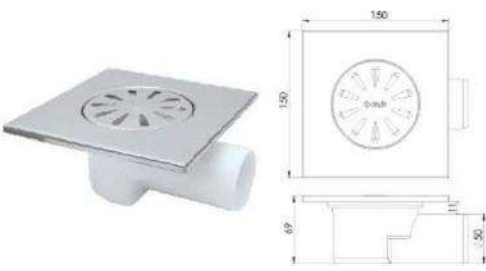

Code - 5106

15x15 Rotary floor drains with stainless steel grid, and Ø50 horizontal outlet

15x15, Ø50 mm Rotary, PP Raw Material, 304 Grade Inox

Pieces In Box	Package Size	Box Weight
50 Pcs	320 x 500 x440 mm	11 Kg

Code - 5107

15x15 Rotary floor drains with stainless steel grid, and Ø50 vertical outlet

15x15, Ø50 mm Outlet From Below Side, PP Raw Material, 304 Grade Inox

Pieces In Box	Package Size	Box Weight
45 Pcs	320 x 500 x440 mm	11 Kg



FILEXIBLE SIPHONS

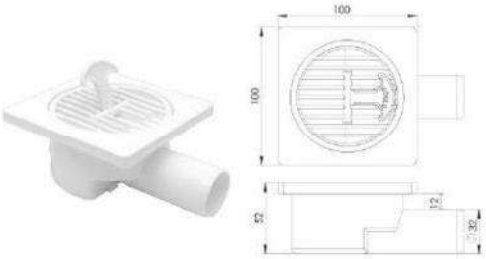

Code - 5108

10x10 PP Rotary floor horizontal Ø32 outlet with plastic grid

10x10, Ø32 mm Rotary, PP Raw Material

Pieces In Box	Package Size	Box Weight
90 Pcs	320 x 500 x 440 mm	9 Kg

Code - 5109

10x10 PP Rotary floor horizontal Ø50 outlet with plastic grid

10x10, Ø50 mm Rotary, PP Raw Material



Pieces In Box	Package Size	Box Weight
70 Pcs	320 x 500 x 440 mm	8 Kg



Code - 5110

15x15 PP Rotary floor horizontal Ø32 outlet with plastic grid

15x15, Ø32 mm Rotary, PP Raw Material

Pieces In Box	Package Size	Box Weight
60 Pcs	320 x 500 x 440 mm	7 Kg

Code - 5111

15x15 PP Rotary floor horizontal Ø50 outlet with plastic grid

15x15, Ø50 mm Rotary, PP Raw Material

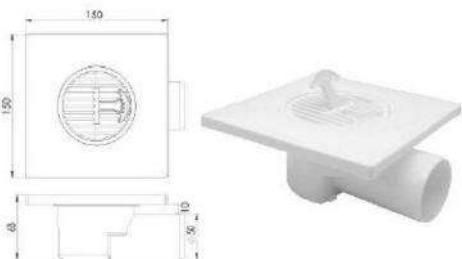

Pieces In Box	Package Size	Box Weight
50 Pcs	320 x 500 x 440 mm	7 Kg

FILEXIBLE SIPHONS

Code - 5112

15x15 PP Rotary floor horizontal Ø70 outlet with plastic grid

15x15, Ø70 mm Rotary, PP Raw Material

Pieces In Box	Package Size	Box Weight
40 Pcs	430 x 600 x 410 mm	11 Kg

Code - 5113

15x15 PP Floor horizontal Ø70 outlet with plastic grid

15x15, Ø70 mm From side , Stable, PP Raw Material

Pieces In Box	Package Size	Box Weight
50 Pcs	430 x 600 x 410 mm	9 Kg

Code - 5114

10x10 PP Floor vertical Ø50 outlet with plastic grid

10x10, Ø50 mm Outlet From Below side, PP Raw Material

Pieces In Box	Package Size	Box Weight
120 Pcs	320 x 500 x 440 mm	8 Kg

Code - 5115

15x15 PP Floor vertical Ø50 outlet with plastic grid

15x15, Ø50 mm Outlet From Below side, PP Raw Material

Pieces In Box	Package Size	Box Weight
50 Pcs	320 x 500 x 440 mm	9 Kg

FILEXIBLE SIPHONS

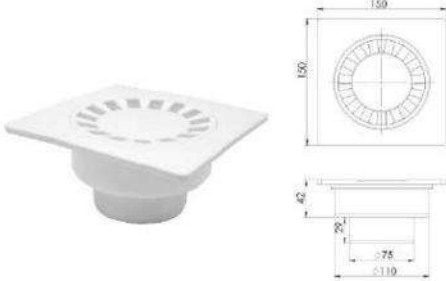

Code - 5116

15x15 PP Floor vertical $\varnothing 70$ outlet with plastic grid

15x15, $\varnothing 70$ mm Outlet From Below Side, PP Raw Material

Pieces In Box	Package Size	Box Weight
70 Pcs	430 x 600 x 410 mm	11 Kg

Code - 5117

Balcony corner drains $\varnothing 70$

$\varnothing 70$ mm



Pieces In Box	Package Size	Box Weight
40 Pcs	425 x 595 x 415 mm	10 Kg

Code - 5118

Balcony corner drains $\varnothing 100$

$\varnothing 100$ mm



Pieces In Box	Package Size	Box Weight
20 Pcs	460 x 570 x 450 mm	7 Kg

FILEXIBLE SIPHONS

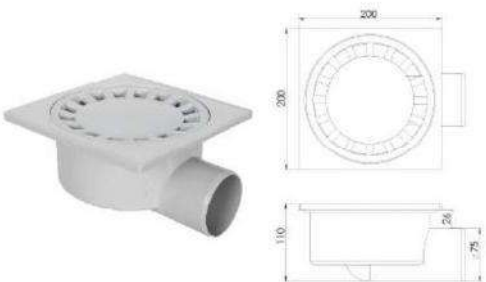

Code - 5119

20x20 Floor drains with bottle and horizontal $\varnothing 70$ outlet for outdoor usage

20x20, $\varnothing 70$ mm From Side

Pieces In Box	Package Size	Box Weight
24 Pcs	460 x 570 x 450 mm	14 Kg

Code - 5120

20x20 Floor drains with bottle and vertical $\varnothing 70$ outlet for outdoor usage

20x20, $\varnothing 70$ mm Outlet From Below Side

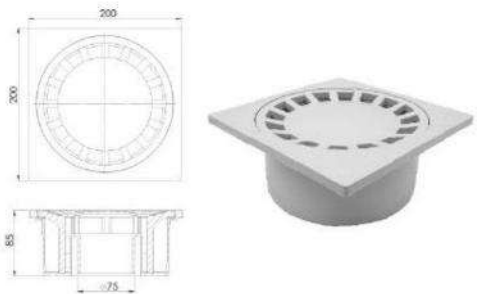

Pieces In Box	Package Size	Box Weight
30 Pcs	460 x 570 x 450 mm	16 Kg

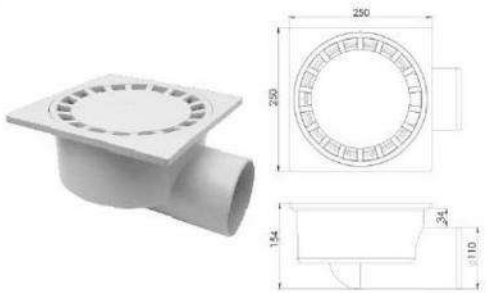

Code - 5121

25x25 Floor drains with bottle and horizontal $\varnothing 100$ outlet for outdoor usage

25x25, $\varnothing 100$ mm From Side

Pieces In Box	Package Size	Box Weight
12 Pcs	610 x 750 x 375 mm	15 Kg

Code - 5122

25x25 Floor drains with bottle and vertical $\varnothing 100$ outlet for outdoor usage

25x25, $\varnothing 100$ mm Outlet From Below Side

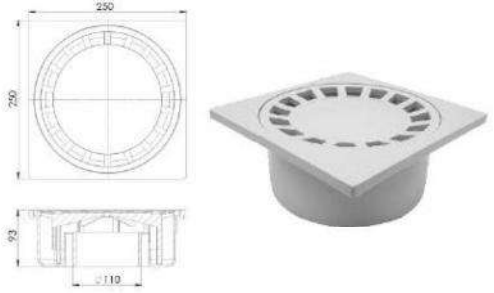

Pieces In Box	Package Size	Box Weight
24 Pcs	610 x 750 x 375 mm	23 Kg

FILEXIBLE SIPHONS

Code - 6100



050 mmx100 mmx500 mm PP floor drains set with horizontal and vertical outlet for outdoor usage

050 x 100 x 500 Plastic, Set

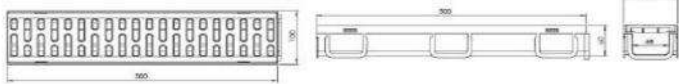

Pieces In Box	Package Size	Box Weight
24 Pcs	510 x 600 x 610 mm	24 Kg



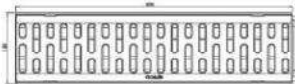

Code - 6101

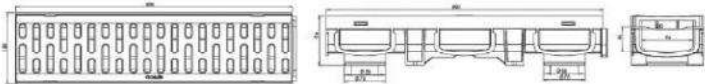

075 mmx130 mmx500 mm PP floor drains set with horizontal and vertical outlet for outdoor usage

075 x 130 x 500 Plastic, Set

Pieces In Box	Package Size	Box Weight
20 Pcs	510 x 600 x 610 mm	26 Kg



Code - 6102



125 mmx200 mmx500 mm PP floor drains set with horizontal and vertical outlet for outdoor usage

125 x 200 x 500 Plastic, Set



Pieces In Box	Package Size	Box Weight
20 Pcs	510 x 600 x 610 mm	45 Kg



FILEXIBLE SIPHONS

Code - 6103

075 mmx130 mmx1000 mm PP floor drains set with horizontal and vertical outlet for outdoor usage

075 x 130 x 1000 Plastic, Set

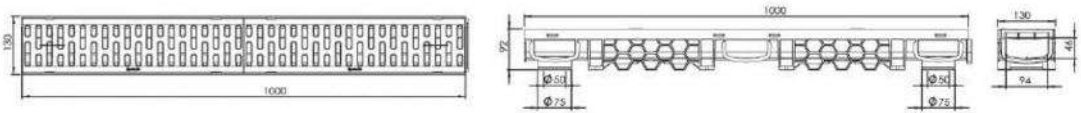
Pieces In Box	Package Size	Box Weight
10 Pcs	510 x 600 x 610 mm	26 Kg

Code - 6104

050 mmx110 mmx500 mm PP floor drains grid for outdoor usage



050 x 100 x 500 Plastic

Pieces In Box	Package Size	Box Weight
20 Pcs	510 x 600 x 610 mm	10 Kg

Code - 6105

075 mmx130 mmx500 mm PP floor drains grid for outdoor usage



075 x 130 x 500 Plastic

Pieces In Box	Package Size	Box Weight
20 Pcs	510 x 600 x 610 mm	12,5 Kg

Code - 6106

125 mmx200 mmx500 mm PP floor drains grid for outdoor usage



125 x 200 x 500 Plastic

Pieces In Box	Package Size	Box Weight
20 Pcs	510 x 600 x 610 mm	20 Kg

Code - 6107

PP stopper for 100 mm floor drains



100 mm

Pieces In Box	Package Size	Box Weight
100 Pcs	510 x 600 x 610 mm	4 Kg

Code - 6108

PP stopper for 130 mm floor drains



130 mm

Pieces In Box	Package Size	Box Weight
100 Pcs	510 x 600 x 610 mm	5 Kg

Code - 6109

PP stopper for 200 mm floor drains



200 mm

Pieces In Box	Package Size	Box Weight
100 Pcs	600 x 510 x 720 mm	13 Kg

FILEXIBLE SIPHONS

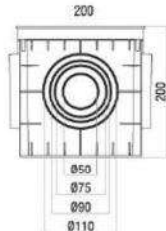

Code - 6125
20x20x20 Underground Junction Box + Plain Gray Cover

Code - 6126
20x20x20 Underground Junction Box Without Cover

Code - 6127
20x20x20 Plain Gray Cover

Code - 6128
30x30x30 Underground Junction Box + Plain Gray Cover

Code - 6129
30x30x30 Underground Junction Box Without Cover

Code - 6130
30x30x30 Plain Gray Cover

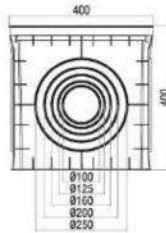
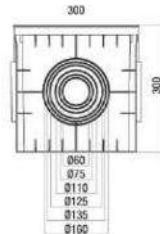

Code - 6131
40x40x40 Underground Junction Box + Plain Gray Cover

Code - 6132
40x40x40 Underground Junction Box Without Cover

Code - 6133
40x40x40 Plain Gray Cover

Code - 6134
48x48x45 Underground Junction Box + Plain Gray Cover

Code - 6135
47,5x47,5x45 Underground Junction Box Without Cover

Code - 6136
48x48x45 Plain Gray Cover

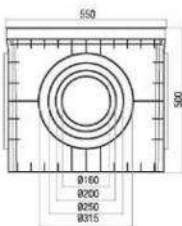
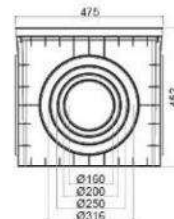

Code - 6137
55x55x50 Underground Junction Box + Plain Gray Cover

Code - 6138
55x55x50 Underground Junction Box Without Cover

Code - 6139
55x55x50 Plain Gray Cover

FILEXIBLE SIPHONS

Code - 6110



Horizontal outlet shower drains with plastic body and stainless steel grid, for indoor usage - 33cm

Rain From, 33 cm, 304 Inox Methal Plate

Pieces In Box	Package Size	Box Weight
35 Pcs	460 x 850 x 390 mm	26 Kg

Code - 6111

Horizontal outlet shower drains with plastic body and stainless steel grid, for indoor usage - 40 cm

Rain From, 40 cm, 304 Inox Methal Plate



Pieces In Box	Package Size	Box Weight
28 Pcs	460 x 850 x 390 mm	24 Kg

Code - 6112

Horizontal outlet shower drains with plastic body and stainless steel grid, for indoor usage - 50 cm

Rain From, 50 cm, 304 Inox Methal Plate



Pieces In Box	Package Size	Box Weight
30 Pcs	520 x 630 x 600 mm	33 Kg

Code - 6113

Horizontal outlet shower drains with plastic body and stainless steel grid, for indoor usage - 60 cm

Rain From, 60 cm, 304 Inox Methal Plate



Pieces In Box	Package Size	Box Weight
24 Pcs	510 x 600 x 610 mm	33 Kg

Code - 6114

Horizontal outlet shower drains with plastic body and stainless steel grid, for indoor usage - 80 cm

Rain From, 80 cm, 304 Inox Methal Plate



Pieces In Box	Package Size	Box Weight
20 Pcs	510 x 600 x 610 mm	35 Kg

FILEXIBLE SIPHONS

Code - 6115



Horizontal outlet ceramic level shower drains with plastic body and stainless steel grid, for indoor usage - 33cm

Newline From, 33 cm, 304 Inox Methal Plate, Gauge With Ceramic

Pieces In Box	Package Size	Box Weight
20 Pcs	600 x 510 x 720 mm	41 Kg

Code - 6116

Horizontal outlet ceramic level shower drains with plastic body and stainless steel grid, for indoor usage - 40 cm

Newline From, 40 cm, 304 Inox Methal Plate, Gauge With Ceramic



Pieces In Box	Package Size	Box Weight
24 Pcs	510 x 600 x 610 mm	33 Kg

Code - 6117



Horizontal outlet ceramic level shower drains with plastic body and stainless steel grid, for indoor usage - 50 cm

Newline From, 50 cm, 304 Inox Methal Plate, Gauge With Ceramic

Pieces In Box	Package Size	Box Weight
20 Pcs	510 x 600 x 610 mm	35 Kg

Code - 6118

Horizontal outlet ceramic level shower drains with plastic body and stainless steel grid, 60 cm

Newline From, 60 cm, 304 Inox Methal Plate, Gauge With Ceramic



Pieces In Box	Package Size	Box Weight
20 Pcs	600 x 510 x 720 mm	41 Kg

Code - 6119



Horizontal outlet ceramic level shower drains with plastic body and stainless steel grid for indoor usage, 80 cm

Newline From, 80 cm, 304 Inox Methal Plate, Gauge With Ceramic

Pieces In Box	Package Size	Box Weight
14 Pcs	920 x 360 x 600 mm	36 Kg

FILEXIBLE SIPHONS



Code - 7100

Corner corrector for floor heating system

Plastic

Pieces In Box	Package Size	Box Weight
300 Pcs	410 x 590 x 370 mm	10 Kg

Code - 7101

Sheet bar with clamp for floor heating system

Plastic 35 cm

Pieces In Box	Package Size	Box Weight
500 Pcs	425 x 595 x 415 mm	13 Kg

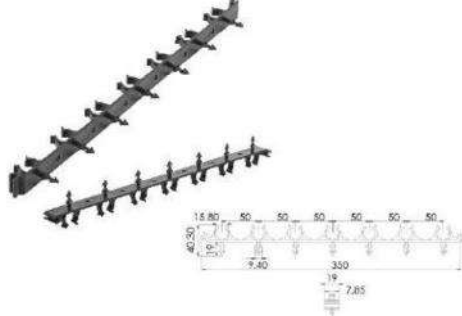

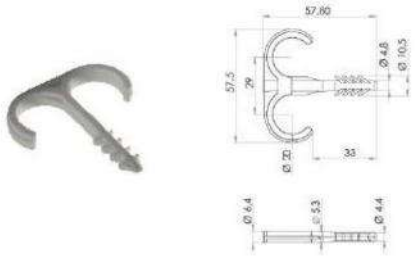

Code - 7102

Double floor dowel for floor heating system

Plastic PP

Pieces In Box	Package Size	Box Weight
5000 Pcs	410 x 590 x 370 mm	13 Kg

Code - 7103

Hose holder for floor heating system

Plastic

Pieces In Box	Package Size	Box Weight
10000 Pcs	410 x 590 x 370 mm	15 Kg



FILEXIBLE SIPHONS

Code - 7104

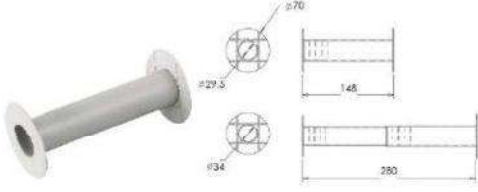

3/4" pipe for wall separation

Plastic, 3/4

Pieces In Box	Package Size	Box Weight
150 Pcs	400 x 590 x 370 mm	6 Kg

Code - 7105

1" pipe for wall separation

Plastic, 1"



Pieces In Box	Package Size	Box Weight
150 Pcs	400 x 590 x 370 mm	6 Kg

Code - 7106



PVC - waste water pipe clamp 50 mm

50 mm , PVC

Pieces In Box	Package Size	Box Weight
150 Pcs	230 x 410 x 250 mm	6 Kg

Code - 7107

PVC - waste water pipe clamp 70 mm

70 mm , PVC



Pieces In Box	Package Size	Box Weight
250 Pcs	350 x 470 x 405 mm	12 Kg

Code - 7108



PVC - waste water pipe clamp 100 mm

100 mm , PVC

Pieces In Box	Package Size	Box Weight
150 Pcs	350 x 470 x 405 mm	12 Kg

FILEXIBLE SIPHONS



Code - 8100

Culvert with wings 28 cm x 38 cm

Plastic, 28 x 38 cm

Pieces In Box	Package Size	Box Weight
15 Pcs	410 x 360 x385 mm	7 Kg

Culvert with wings 33 cm x 45 cm

Plastic, 33 x 45 cm

Pieces In Box	Package Size	Box Weight
15 Pcs	455 x 370 x350 mm	10 Kg

Code - 8101





Code - 8102

Culvert with wings 35 cm x 55 cm

Plastic, 35 x 55 cm

Pieces In Box	Package Size	Box Weight
15 Pcs	525 x 570 x380 mm	12 Kg

Culvert with wings 43 cm x 45 cm

Plastic, 43 x 45 cm

Pieces In Box	Package Size	Box Weight
15 Pcs	460 x 200 x 450 mm	12 Kg

Code - 8103



FILEXIBLE SIPHONS



Code - 8104

Culvert with wings 43 cm x 53 cm

Plastic 43x53 cm

Pieces In Box	Package Size	Box Weight
15 Pcs	525 x 530 x 445 mm	15 Kg

Code - 8105

Culvert with wings 53 cm x 55 cm

Plastic 53x55 cm

Pieces In Box	Package Size	Box Weight
15 Pcs	525 x 545 x 545 mm	18 Kg





Code - 8106

Culvert with wings 58 cm x 66 cm

Plastic 58x66 cm

Pieces In Box	Package Size	Box Weight
15 Pcs	460 x 200 x 450 mm	12 Kg

Code - 8107

Glass grill for air ventilation

Pieces In Box	Package Size	Box Weight
100 Pcs	460 x 200 x 450 mm	12 Kg



FILEXIBLE SIPHONS



Stainless Steel Flex Connection Hose

Code	Pieces In Box 25 Pcs
8500	3/8 - 3/8 (30 cm)
8501	3/8 - 3/8 (40 cm)
8502	3/8 - 3/8 (50 cm)
8503	3/8 - 3/8 (60 cm)
8504	3/8 - 3/8 (70 cm)
8505	3/8 - 3/8 (100 cm)



Stainless Steel Flex Connection Hose With Nipel

Code	Pieces In Box 25 Pcs
8506	3/8 - 3/8 (30 cm)
8507	3/8 - 3/8 (40 cm)
8508	3/8 - 3/8 (50 cm)
8509	3/8 - 3/8 (60 cm)
8510	3/8 - 3/8 (70 cm)
8511	3/8 - 3/8 (100 cm)



Stainless Steel Flex Connection Hose

Code	Pieces In Box 25 Pcs
8512	3/8 - 1/2 (30 cm)
8513	3/8 - 1/2 (40 cm)
8514	3/8 - 1/2 (50 cm)
8515	3/8 - 1/2 (60 cm)
8516	3/8 - 1/2 (70 cm)
8517	3/8 - 1/2 (100 cm)



Stainless Steel Flex Connection Hose With Nipel

Code	Pieces In Box 25 Pcs
8518	3/8 - 3/8 (30 cm)
8519	3/8 - 3/8 (50 cm)
8520	3/8 - 3/8 (70 cm)



Stainless Steel Flex Connection Hose

Code	Pieces In Box 25 Pcs
8521	1/2 - 1/2 (30 cm)
8522	1/2 - 1/2 (40 cm)
8523	1/2 - 1/2 (50 cm)
8524	1/2 - 1/2 (60 cm)
8525	1/2 - 1/2 (70 cm)
8526	1/2 - 1/2 (100 cm)



3/8 Long Groove Stainless Steel For Hose Faucet

Code	Pieces In Box 25 Pcs
8507	3/8 - 3/8 (40 cm)
8508	3/8 - 3/8 (50 cm)
8509	3/8 - 3/8 (60 cm)
8510	3/8 - 3/8 (70 cm)
8511	3/8 - 3/8 (100 cm)

FILEXIBLE SIPHONS



Code - 9100

1 1/4 - 32 mm Outlet Flexible Pipe 85 cm

Pieces In Box	Package Size	Box Weight
175 Pcs	460 x 570 x 450 mm	14 Kg



Code - 9101

1 1/4 - 32 mm Outlet Flexible Pipe 140 cm

Pieces In Box	Package Size	Box Weight
125 Pcs	460 x 570 x 450 mm	14 Kg



Code - 9102

1 1/4 - 40-50 mm Outlet Flexible Pipe 85 cm

Pieces In Box	Package Size	Box Weight
145 Pcs	460 x 570 x 450 mm	12 Kg



Code - 9103

1 1/4 - 32 mm Outlet Flexible Pipe 85 cm

Pieces In Box	Package Size	Box Weight
170 Pcs	460 x 570 x 450 mm	11 Kg



Code - 9104

1 1/2 - 32 mm Outlet Flexible Pipe 140 cm

Pieces In Box	Package Size	Box Weight
120 Pcs	460 x 570 x 450 mm	12 Kg



Code - 9105

1 1/2 - 40-50 mm Outlet Flexible Pipe 85 cm

Pieces In Box	Package Size	Box Weight
140 Pcs	460 x 570 x 450 mm	13 Kg

FILEXIBLE SIPHONS



Code - 9108

65 mm Siphon Head With Plug Inbox

65 mm 304 Grade Inox Trap, 1/4"65 mm Inox Screw

Pieces In Box	Package Size	Box Weight
15 Pcs	525 x 530 x 445 mm	15 Kg



Code - 9109

70 mm Siphon Head With Plug Inbox

70 mm 304 Grade Inox Trap, 1/4"65 mm Inox Screw

Pieces In Box	Package Size	Box Weight
15 Pcs	525 x 545 x 545 mm	18 Kg



Code - 9110

80 mm Siphon Head With Plug Inbox

80 mm 304 Grade Inox Trap, 1/4"65 mm Inox Screw

Pieces In Box	Package Size	Box Weight
15 Pcs	460 x 200 x 450 mm	12 Kg



Code - 9111

110 mm Siphon Head With Plug Inbox

110 mm 304 Grade Inox Trap, 1/4"65 mm Inox Screw

Pieces In Box	Package Size	Box Weight
15 Pcs	460 x 200 x 450 mm	12 Kg

FILEXIBLE SIPHONS



Code - 9112

PP Shower Drains Spare Part

Pieces In Box	Package Size	Box Weight
Pcs	320 x 500 x 440 mm	Kg



Code - 9113

**70 mm
PP Shower Drains Spare Part**

Pieces In Box	Package Size	Box Weight
Pcs	320 x 500 x 440 mm	Kg



Code - 9114

**70 mm
PP Shower Drains Spare Part**

Pieces In Box	Package Size	Box Weight
Pcs	320 x 500 x 440 mm	Kg



Code - 9115

**50 mm
PP Shower Drains Spare Part**

Pieces In Box	Package Size	Box Weight
Pcs	320 x 500 x 440 mm	Kg



Code - 9116

**70 mm
PP Shower Drains Spare Part**

Pieces In Box	Package Size	Box Weight
Pcs	320 x 500 x 440 mm	Kg



Code - 9117

**100 mm
PP Shower Drains Spare Part**

Pieces In Box	Package Size	Box Weight
Pcs	320 x 500 x 440 mm	Kg



Code - 9118

Siphon Outlet Spare Part

Pieces In Box	Package Size	Box Weight
Pcs	320 x 500 x 440 mm	Kg

FILEXIBLE SIPHONS



Code - 9119

Flow Horizontal Hose

Pieces In Box	Package Size	Box Weight
Pcs	320 x 500 x 440 mm	Kg



Code - 9120

Flow Vertical Hose

Pieces In Box	Package Size	Box Weight
Pcs	320 x 500 x 440 mm	Kg



Code - 9121

Head Of Flow Horizontal Hose

Pieces In Box	Package Size	Box Weight
Pcs	320 x 500 x 440 mm	Kg



Code - 9122

Head Of Flow Vertical Hose

Pieces In Box	Package Size	Box Weight
Pcs	320 x 500 x 440 mm	Kg



Code - 9123

Gasket For Flexible Pipe Nut

Pieces In Box	Package Size	Box Weight
Pcs	320 x 500 x 440 mm	Kg



Code - 9124

Gasket Under Siphon Head Plate

Pieces In Box	Package Size	Box Weight
Pcs	320 x 500 x 440 mm	Kg

Avrasia

Radiator



PANEL RADIATORS



THERMAL CAPACITY IN 80 °C (90 °C/70 °C) WATER TEMPERATURE 43/10

Interior Temperature

Type	Height	12 °C		15 °C		18 °C		20 °C		22 °C		24 °C		26 °C	
		watt	kcal/h	watt	kcal/h	watt	kcal/h	watt	kcal/h	watt	kcal/h	watt	kcal/h	watt	kcal/h
22	300	1851	1592	1749	1504	1639	1410	1573	1353	1499	1289	1430	1230	1368	1176
	400	2129	1831	2011	1729	1884	1620	1810	1556	1724	1482	1644	1414	1574	1353
	500	2464	2119	2327	2001	2181	1875	2095	1801	1995	1715	1904	1637	1820	1566
	600	3117	2680	2944	2531	2760	2373	2649	2278	2524	2170	2407	2070	2304	1981
	900	4279	3679	4041	3475	3789	3258	3637	3127	3463	2978	3308	2844	3162	2719

TYPE 22

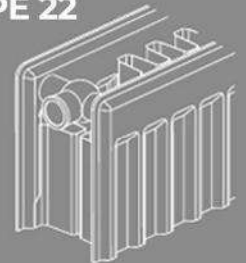

Technical Information	Type	Height (mm)	Junction axis (mm)	Width (mm)	Length min-max (mm)	Water capacity (lt/m)	Weight (kg/m)
	Type 22	300	245	104	400-3000	3.4	17
		400	345			4.3	21.5
		500	445			5.1	27.2
		550	500			5.6	29.2
		600	545			6.1	31.9
		900	845			8.2	48.5



PANEL RADIATORS

TEST PRESSURE	MAX WATER TEMPERATURE	NUMBER OF CONNECTIONS
13 BAR	110 °C	4xDIN G ^{1/2}
MAX OPERATING PRESSURE	WARRANTY	
10 BAR	10 YEARS	



. Latest Technology Painting

Type 22 panel radiators are cleaned by means of a set of treatments namely degreasing by immersion, degreasing by spray, iron-phosphate coating and passivation. Radiators primed by wet undercoating painting, immersion method and kiln-dried are dyed in RAL 9016 color by means of robot guns with the electrostatic epoxy powder-coating method and finishes with drying



. High Quality Product

High quality Erdemir cold rolled sheet metals use in production of steel panel radiators.



. Maximum Quality and Warranty

It makes production in modern facilities with ISO-9001 quality certificate in accordance with TS EN 442 standards. Each radiator is exposed to 13 bar test and is resistant to 10 bar operating pressure. The warranty is 10 years.

. Safety Packaging

Type 22 panel radiators are packed with bubble nylon packages and supported edge cardboards to ensure protection from outer impacts during transport and installation.



. High Efficiency

Type 22 panel radiators boast the maximum thermal efficiency with 33.3 mm-pitch water channel conduits and wide convector surface.



. Modern and Stylish Design

Type 22 panel radiators are modern with its smooth surface and stylish touch with its aesthetical design. It provides an elegant appearance to the decoration of the rooms.



. Easy Installation

Installation materials (hanging equipment, valve cork, blind flange, clips to hang the console, rawplugs and trifen screws) are included. The installation of the radiators is practical, it can be installed easily.



TOWEL WARMER



SIZE					HEATING TABLE			
WIDTH (A) mm	HEIGHT (A) mm	Attachment Distance (L) mm	Number of Pipes	Water Capacity (L) mm	ELECTROSTATIC PAINTED		CHROME COATED	
					Watt	Kcal	Watt	Kcal
400	700	338	15	2,90	277	238	183	157
	800	358	17	3,28	314	270	207	178
	1000	396	20	3,95	379	325	250	215
	1100	386	23	4,63	436	375	288	247
	1200	356	25	4,82	464	399	306	263
	1400	358	28	5,49	529	455	349	300
	1600	356	33	6,35	615	529	408	349
500	700	456	15	3,37	327	281	216	185
	800	456	17	3,81	371	319	245	200
	1000	456	20	4,58	445	383	294	253
	1100	456	23	5,15	512	441	338	291
	1200	496	25	5,60	566	470	360	310
	1400	456	28	6,37	622	534	400	353
	1600	456	33	7,39	723	622	477	410
600	700	596	15	3,84	384	330	253	218
	800	596	17	4,35	436	375	288	248
	1000	556	20	5,21	524	451	346	297
	1100	556	23	5,87	594	511	392	337
	1200	556	25	6,39	645	555	426	366
	1400	556	28	7,25	734	631	484	417
	1600	556	33	8,63	877	777	600	498

Avrasia

Natural Gas Materials

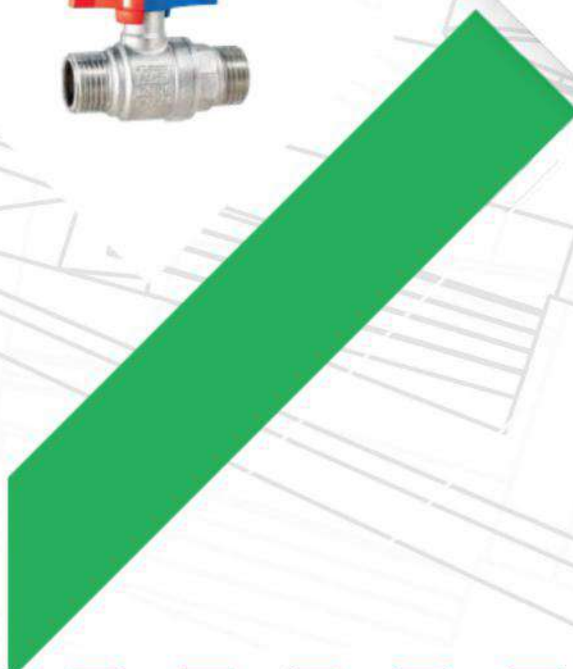

▶ NATURAL GAS VALVE (FULL PORT)



CODE	SIZE	BOX
125	1/2" DN15	100
126	3/4" DN20	50
127	1" DN25	35
128	1 1/4" DN32	15
129	1 1/2" DN40	10
130	2" DN50	10

▶ NATURAL GAS VALVE (LOCKED TYPE - FULL PORT)



CODE	SIZE	BOX
125-K	1/2" DN15	75
126-K	3/4" DN20	50
127-K	1" DN25	35

▶ NATURAL GAS VALVE (FEMALE / T-HANDLE)



CODE	SIZE	BOX
210-KS	1/2" DN15	80
211-KS	3/4" DN20	50
212-KS	1" DN25	30

▶ NATURAL GAS VALVE (MALE / FEMALE - T-HANDLE)



CODE	SIZE	BOX
215-KS	1/2" DN15	80
216-KS	3/4" DN20	50
217-KS	1" DN25	30

▶ GAS FILTER



CODE	SIZE	BOX
132	1/2" DN15	100
133	3/4" DN20	60
134	1" DN25	30

▶ SELONOID GAS VALVE



CODE	SIZE	BOX
120	220 V 1/2" DN15	10
121	220 V 3/4" DN20	10
122	220 V 1" DN25	10
120-1	220 V 1/2" DN15	10
121-1	220 V 3/4" DN20	10
122-1	220 V 1" DN25	10

▶ BALL VALVE - PN25 (FEMALE - FULL PORT)



CODE	SIZE	BOX
101	1/2" DN15	100
102	3/4" DN20	50
103	1" DN25	35
104	1 1/4" DN32	15
105	1 1/2" DN40	10
106	2" DN50	10
107	2 1/2" DN65	6
108	3" DN80	2
109	4" DN100	2

▶ BALL VALVE - PN16 (EN 13547 - FEMALE - FULL PORT)



CODE	SIZE	BOX
101-K	1/2" DN15	100
102-K	3/4" DN20	50
103-K	1" DN25	35
104-K	1 1/4" DN32	15
105-K	1 1/2" DN40	10
106-K	2" DN50	10
107-K	2 1/2" DN65	6

▶ BALL VALVE - PN10 (EN 13828 - FEMALE - FULL PORT)



CODE	SIZE	BOX
101-l	1/2" DN15	100
102-l	3/4" DN20	50
103-l	1" DN25	35
104-l	1 1/4" DN32	15
105-l	1 1/2" DN40	10
106-l	2" DN50	10
107-l	2 1/2" DN65	6

▶ BALL VALVE WITH FITTINGS - PN25
(FULL PORT / T-HANDLE)



CODE	SIZE	BOX
116	1/2" DN15	50
117	3/4" DN20	34
118 LIGHT	1" DN25	30
118-1 HEAVY	1" DN25	24
119	1 1/4" DN32	14

▶ BALL VALVE WITH FITTINGS / T-HANDLE
(WITH THERMOCOUPLE CONNECTION)



CODE	SIZE	BOX
117-T	3/4" DN20	34
118-T	1" DN25	24
119-T	1 1/4" DN32	14

▶ BALL VALVE WITH T-HANDLE
(FEMALE / WITH THERMOCOUPLE CONNECTION)



CODE	SIZE	BOX
212-T	1" DN25	30

▶ BALL VALVE WITH FITTINGS / T-HANDLE
(FEMALE / WITH THERMOMETER)



CODE	SIZE	BOX
118TM	1" DN25	20

▶ BALL VALVE - PN25
(MALE-FEMALE / FULL PORT / T-HANDLE)



CODE	SIZE	BOX
215	1/2" DN15	80
216	3/4" DN20	50
217	1" DN25	30
218	1 1/4" DN25	20

▶ BALL VALVE - PN25
(MALE/ FULL PORT / T-HANDLE)



CODE	SIZE	BOX
219	1/2" DN15	74
219-1	3/4" DN20	50
219-2	1" DN25	30

▶ MINI BALL VALVE (MALE-FEMALE)



CODE	SIZE	BOX
403	1/4" DN8	150
404	3/8" DN10	150
405	1/2" DN15	150
406	3/4" DN20	100

▶ SPHERICAL TAPS



CODE	SIZE	BOX
209-1	3/4"	50
209-4	3/4"-1/2"	50
209-44	3/4"-3/4"	50

▶ BALL VALVE- PN25
(FEMALE / T-HANDLE)



CODE	SIZE	BOX
210	1/2" DN15	80
211	3/4" DN20	50
212	1" DN25	30
213	1 1/4" DN32	10

▶ BALL VALVE WITH FILTER (T-HANDLE)



CODE	SIZE	BOX
110	1/2" DN15	50
111	3/4" DN20	50

▶ BALL VALVE WITH FILTER (FAN-COIL / T-HANDLE)



CODE	SIZE	BOX
110-1	1/2" DN15	50
111-1	3/4" DN20	50
112-1	1" DN25	26

▶ MINI BALL VALVE (MALE / PE-XB CONNECTION)



CODE	SIZE	BOX
398	1/2"-16x2"	100
399	1/2"-17x2"	100
400	1/2"-20x2"	100

▶ BALL VALVE WITH PPRC CONNECTION



CODE	SIZE	BOX
342	1/2"-20mm	50
343	3/4"-25mm	35
344	1"-32mm	26
345	1 1/4"-40mm	15
346	1 1/2"-50mm	10
347	2"-63mm	6

▶ BALL VALVE WITH FILTER AND FITTINGS (T-HANDLE)



CODE	SIZE	BOX
113	1/2" DN15	34
114	3/4" DN20	34

▶ BALL VALVE WITH FILTER & FITTING (T-HANDLE)



CODE	SIZE	BOX
115	1" DN25	20

▶ MINI BALL VALVE (FEMALE / PE-XB CONNECTION)



CODE	SIZE	BOX
401	1/2"-16x2	100

TSEK

▶ CORNER RADIATOR VALVE



CODE	SIZE	BOX
151	1/2"	80
151-1 Oring	1/2"	80
302	3/4"	50

▶ STRAIGHT RADIATOR VALVE



CODE	SIZE	BOX
155	1/2"	80
155-1 Oring	1/2"	80
154	3/4"	50

▶ CORNER RETURN RADIATOR VALVE



CODE	SIZE	BOX
315	1/2"	80
315-1 Oring	1/2"	80

▶ CORNER RETURN RADIATOR VALVE (PE-XB CONNECTION / 16x2)



CODE	SIZE	BOX
245	1/2"	80
245-1 Oring	1/2"	80

▶ CORNER RADIATOR VALVE (LIGHT TYPE)



CODE	SIZE	BOX
152	1/2"	80
152-1 Oring	1/2"	80

▶ CORNER RADIATOR VALVE (PE-XB CONNECTION / 16x2)



CODE	SIZE	BOX
303	1/2"	80
303-1 Oring	1/2"	80

▶ STRAIGHT RETURN RADIATOR VALVE



CODE	SIZE	BOX
316	1/2"	80
316-1 Oring	1/2"	80

▶ THERMOSTATIC RADIATOR VALVE & HEADS



CODE	SIZE	BOX
305	1/2"	50
305-1 Oring	1/2"	50

► STRAIGHT RADIATOR VALVE (PE-XB CONNECTION- 16x2)



CODE	SIZE	BOX
156	1/2"	80
156-1 Oring	1/2"	80

► CORNER RADIATOR VALVE (PPRC CONNECTION)



CODE	SIZE	BOX
304	1/2"- 20 mm	50
304-1 Oring	1/2"- 20 mm	50

► STRAIGHT RADIATOR VALVE (CHROME PLATED)



CODE	SIZE	BOX
155-K	1/2"	35
155-K1 Oring	1/2"	35

► CORNER RADIATOR VALVE (CHROME , PE-XB 16x2)



CODE	SIZE	BOX
303-K	1/2"	35
303-K1 Oring	1/2"	35

► STRAIGHT RETURN RADIATOR VALVE
(PE-XB CONNECTION - 16x2)



CODE	SIZE	BOX
317	1/2"	80
317-1 Oring	1/2"	80

► CORNER RADIATOR VALVE (CHROME PLATED)



CODE	SIZE	BOX
150-K	1/2"	35
150-K1 Oring	1/2"	35

► CORNER RETURN RADIATOR VALVE (CHROME PLATED)



CODE	SIZE	BOX
315-K	1/2"	35
315-K1 Oring	1/2"	35

► CORNER RETURN RADIATOR VALVE (CHROME - PE-XB 16x2)



CODE	SIZE	BOX
245-K	1/2"	35
245-K1 Oring	1/2"	35

► MOBILE FITTINGS - MALE (YELLOW)



CODE	SIZE	BOX
465-1	1/2" x 20	100
465-2	3/4" x 25	60
465-3	1" x 32	40
465-4	1 1/4" x 40	25
465-5	1 1/2" x 50	15
465-6	2" x 63	10

► MOBILE FITTING - FEMALE (YELLOW)



CODE	SIZE	BOX
463-1	1/2" x 20	100
463-2	3/4" x 25	60
463-3	1" x 32	40
463-4	1 1/4" x 40	25
463-5	1 1/2" x 50	15
463-6	2" x 63	10

► UPRIGHT CHECKVALVE



CODE	SIZE	BOX
203-1	1/2" DN15	125
203-2	3/4" DN20	70
203-3	1" DN25	50
203-4	1 1/4" DN32	30
203-5	1 1/2" DN40	25
203-6	2" DN50	16
203-7	2 1/2" DN65	10
203-8	3" DN80	3

► CORNER RADIATOR FITTING



CODE	SIZE	BOX
YELLOW		
325	1/2" DN15	100
326	3/4" DN20	90
327	1" DN25	50
NICKEL PLATED		
320	1/2" DN15	100
321	3/4" DN20	90
322	1" DN25	50

► MOBILE FITTING MALE (NICKEL PLATED)



CODE	SIZE	BOX
464-1	1/2" x 20	100
464-2	3/4" x 25	60
464-3	1" x 32	40
464-4	1 1/4" x 40	25
464-5	1 1/2" x 50	15
464-6	2" x 63	10

► MOBILE FITTING FEMALE (NICKEL PLATED)



CODE	SIZE	BOX
462-1	1/2" x 20	100
462-2	3/4" x 25	60
462-3	1" x 32	40
462-4	1 1/4" x 40	25
462-5	1 1/2" x 50	15
462-6	2" x 63	10

► SWING CHECKVALVE



CODE	SIZE	BOX
201-1	1/2" DN15	100
201-2	3/4" DN20	50
201-3	1" DN25	30
201-4	1 1/4" DN32	20
201-5	1 1/2" DN40	10
201-6	2" DN50	10
201-7	2 1/2" DN65	5
201-8	3" DN80	4
201-9	4" DN100	2

► STRAIGHT RADIATOR FITTING



CODE	SIZE	BOX
YELLOW		
335	1/2" DN15	125
336	3/4" DN20	100
337	1" DN25	50
338	1 1/4" DN32	35
339	1 1/2" DN40	20
340	2" DN50	12
NICKEL PLATED		
329	1/2" DN15	125
330	3/4" DN20	100
331	1" DN25	50
332	1 1/4" DN32	35
333	1 1/2" DN40	20
334	2" DN50	12

▶ PP-R ADAPTOR (NICKEL PLATED)



CODE	SIZE	BOX
466-1	20x20 mm	100
466-2	25x25 mm	50
466-3	32x32 mm	35

▶ EQUAL TEE



CODE	SIZE	BOX
247	16x16x16	100

▶ MALE TEE



CODE	SIZE	BOX
248	16x1/2"x16	100

▶ FEMALE TEE



CODE	SIZE	BOX
249	16x1/2"x16	100

► MALE ELBOW



CODE	SIZE	BOX
253	15x1/2"	150

► EQUAL ELBOW



CODE	SIZE	BOX
250	16x16	150

► MALE ELBOW



CODE	SIZE	BOX
251	16x1/2"	150

► FEMALE ELBOW



CODE	SIZE	BOX
252	16x1/2"	150

▶ PIPE LINK SOCKET (PE-XB ALPE-X)



CODE	SIZE	BOX
427	16x2	200
428	17x2	150

▶ PIPE LINK SOCKET (PE-XB ALPE-X)



CODE	SIZE	BOX
425	16x2-15mm	200
426	17x2-15mm	150

▶ MALE RETURN SOCKET (PE-XB ALPE-X - DETACHABLE)



CODE	SIZE	BOX
422	1/2"-16x2	250
421	1/2" - 17x2	250

▶ MALE RETURN SOCKET (PE-XB ALPE-X)



CODE	SIZE	BOX
419	1/2" - 14x2	250
420	1/2" - 16x2	250

▶ FEMALE RETURN SOCKET (PE-XB ALPE-X)



CODE	SIZE	BOX
410	1/2"-16x2	250
411	1/2"-17x2	250

▶ TEST SOCKET



CODE	SIZE	BOX
415	16x2	300

▶ NIPPLE FOR RADIATOR RETURN



CODE	SIZE	BOX
430	1/2"-15mm	250

▶ STRAIGHT H-VALVE



CODE	SIZE	BOX
413	1/2"-16x2	30
413-1	1/2"-20x2	30

▶ BY-PASS COLLECTOR (ADJUSTABLE)



CODE	SIZE	BOX
442	1/2"-16x2"	30
443	1/2"-17x2"	30

► BRASS MANIFOLD - FEMALE (1") (NICKEL)



CODE	SIZE	BOX
448-2	1" - 2 Ağız	10
448-3	1" - 3 Ağız	10
448-4	1" - 4 Ağız	10
448-5	1" - 5 Ağız	10
448-6	1" - 6 Ağız	10
448-7	1" - 7 Ağız	10
448-8	1" - 8 Ağız	10
448-9	1" - 9 Ağız	10
448-10	1" - 10 Ağız	10
448-11	1" - 11 Ağız	10
448-12	1" - 12 Ağız	10

► BRASS MANIFOLD - FEMALE (1 1/2") (NICKEL)



CODE	SIZE	BOX
450-7	1½" - 7 Ağız	6
450-8	1½" - 8 Ağız	6
450-9	1½" - 9 Ağız	6
450-10	1½" - 10 Ağız	6
450-11	1½" - 11 Ağız	6
450-12	1½" - 12 Ağız	6
450-13	1½" - 13 Ağız	6
450-14	1½" - 14 Ağız	6
450-15	1½" - 15 Ağız	6
450-16	1½" - 16 Ağız	6
450-17	1½" - 17 Ağız	6
450-18	1½" - 18 Ağız	6
450-19	1½" - 19 Ağız	6
450-20	1½" - 20 Ağız	6

► MANIFOLD WITH VALVE (1" 16x2)



CODE	SIZE	BOX
573-2	1"	8
573-3	1"	8
573-4	1"	8
573-5	1"	8
573-6	1"	8
573-7	1"	8
573-8	1"	8
573-9	1"	8
573-10	1"	8
573-11	1"	8
573-12	1"	8
573-13	1"	8
573-14	1"	8
573-15	1"	8

► BRASS MANIFOLD - FEMALE (1") (NICKEL)



CODE	SIZE	BOX
449-5	1¼" - 5 Ağız	8
449-6	1¼" - 6 Ağız	8
449-7	1¼" - 7 Ağız	8
449-8	1¼" - 8 Ağız	8
449-9	1¼" - 9 Ağız	8
449-10	1¼" - 10 Ağız	8
449-11	1¼" - 11 Ağız	8
449-12	1¼" - 12 Ağız	8
449-13	1¼" - 13 Ağız	4
449-14	1¼" - 14 Ağız	4
449-15	1¼" - 15 Ağız	4
449-16	1¼" - 16 Ağız	4
449-17	1¼" - 17 Ağız	4
449-18	1¼" - 18 Ağız	4

► MANIFOLD WITH VALVE (1" - 16x2")

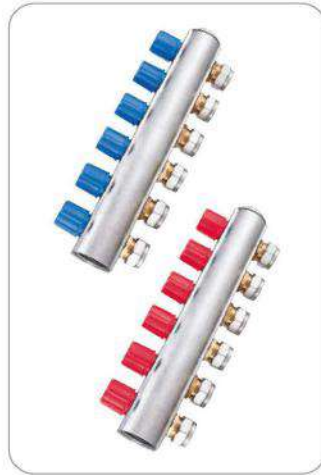

CODE	SIZE	BOX
576-2	1"	16
576-3	1"	12
576-4	1"	8
576-5	1"	6
576-6	1"	8
576-7	1"	8
576-8	1"	8
576-9	1"	8
576-10	1"	8
576-11	1"	6
576-12	1"	6
576-13	1"	6
576-14	1"	6
576-15	1"	6

► MANIFOLD WITH VALVE (1¼" - 16x2")

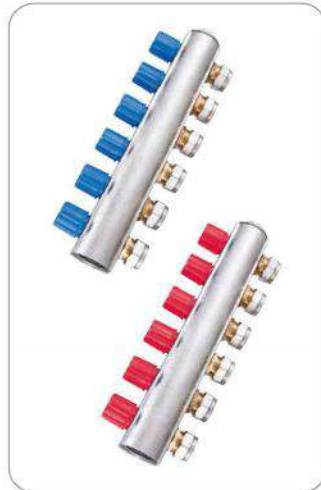

CODE	SIZE	BOX
577-2	1¼"	12
577-3	1¼"	12
577-4	1¼"	6
577-5	1¼"	6
577-6	1¼"	6
577-7	1¼"	8
577-8	1¼"	6
577-9	1¼"	6
577-10	1¼"	6
577-11	1¼"	6
577-12	1¼"	4
577-13	1¼"	4
577-14	1¼"	4
577-15	1¼"	4

▶ MANIFOLD WITH MINI VALVE PE-XB (1")



CODE	SIZE	BOX
1" - 16 x 2"		
570-2	1"	16
570-3	1"	12
570-4	1"	8
570-5	1"	6
570-6	1"	8
570-7	1"	8
570-8	1"	8
570-9	1"	8
570-10	1"	8
570-11	1"	6
570-12	1"	6
570-13	1"	6
570-14	1"	6
570-15	1"	6
1" - 17 x 2"		
575-2	1"	16
575-3	1"	12
575-4	1"	8
575-5	1"	6
575-6	1"	8
575-7	1"	8
575-8	1"	8
575-9	1"	8
575-10	1"	8
575-11	1"	6
575-12	1"	6
575-13	1"	6
575-14	1"	6
575-15	1"	6

▶ HOSE CONSTANT PLASTIC



CODE	BOX
560	200

▶ UNDERFLOOR HEATING PIPE FIXING



CODE	BOX
566	350

▶ MANIFOLD WITH MINI VALVE PE-XB (1 1/4")



CODE	SIZE	BOX
1 1/4" - 16 x 2"		
580-5	1 1/4"	4
580-6	1 1/4"	4
580-7	1 1/4"	4
580-8	1 1/4"	4
580-9	1 1/4"	4
580-10	1 1/4"	4
580-11	1 1/4"	4
580-12	1 1/4"	4
580-13	1 1/4"	4
580-14	1 1/4"	4
580-15	1 1/4"	4
580-16	1 1/4"	4
580-17	1 1/4"	4
580-18	1 1/4"	4

1 1/4" - 17 x 2"		
585-5	1 1/4"	4
585-6	1 1/4"	4
585-7	1 1/4"	4
585-8	1 1/4"	4
585-9	1 1/4"	4
585-10	1 1/4"	4
585-11	1 1/4"	4
585-12	1 1/4"	4
585-13	1 1/4"	4
585-14	1 1/4"	4
585-15	1 1/4"	4
585-16	1 1/4"	4
585-17	1 1/4"	4
585-18	1 1/4"	4

▶ UNDERFLOOR HEATING STAPLE



CODE	BOX
564	8000

▶ UNDERFLOOR HEATING CLIP RAIL



CODE	BOX
565	4000

► FLOW RATE ADJUSTED MANIFOLD (3/4" OUT)



CODE	SIZE	BOX
------	------	-----

1"

DAK3-2	1"	6
DAK3-3	1"	6
DAK3-4	1"	4
DAK3-5	1"	6
DAK3-6	1"	6
DAK3-7	1"	5
DAK3-8	1"	5
DAK3-9	1"	5
DAK3-10	1"	4
DAK3-11	1"	4
DAK3-12	1"	4

1 1/4"

DAK7-2	1 1/4"	2
DAK7-3	1 1/4"	2
DAK7-4	1 1/4"	2
DAK7-5	1 1/4"	2
DAK7-6	1 1/4"	2
DAK7-7	1 1/4"	2
DAK7-8	1 1/4"	2
DAK7-9	1 1/4"	2
DAK7-10	1 1/4"	2
DAK7-11	1 1/4"	2
DAK7-12	1 1/4"	2

► THERMOSTATIC+FLOW RATE MANIFOLD SET (3/4"-16x2)



CODE	SIZE	BOX
------	------	-----

1"

TAK1-2	1"	1 Tk
TAK1-3	1"	1 Tk
TAK1-4	1"	1 Tk
TAK1-5	1"	1 Tk
TAK1-6	1"	1 Tk
TAK1-7	1"	1 Tk
TAK1-8	1"	1 Tk
TAK1-9	1"	1 Tk
TAK1-10	1"	1 Tk
TAK1-11	1"	1 Tk
TAK1-12	1"	1 Tk

1 1/4"

TAK2-2	1 1/4"	1 Tk
TAK2-3	1 1/4"	1 Tk
TAK2-4	1 1/4"	1 Tk
TAK2-5	1 1/4"	1 Tk
TAK2-6	1 1/4"	1 Tk
TAK2-7	1 1/4"	1 Tk
TAK2-8	1 1/4"	1 Tk
TAK2-9	1 1/4"	1 Tk
TAK2-10	1 1/4"	1 Tk
TAK2-11	1 1/4"	1 Tk
TAK2-12	1 1/4"	1 Tk

Ingredients:

- 1 pcs. Flow Rate Manifold,
- 1 pcs. Therm. Rate Manifold
- 2 pcs. Relief Valve
- 1 set. Clamps
- 1 pcs. Automatic Air Vent
- 1 pcs. Mec. Air Vent
- Hose Links (16x2)

► THERMOSTATIC ADJUSTED MANIFOLD (3/4" OUT)



CODE	SIZE	BOX
1"		
TAK3-2	1"	12
TAK3-3	1"	9
TAK3-4	1"	6
TAK3-5	1"	6
TAK3-6	1"	8
TAK3-7	1"	8
TAK3-8	1"	8
TAK3-9	1"	6
TAK3-10	1"	6
TAK3-11	1"	6
TAK3-12	1"	6
1 1/4"		
TAK7-2	1 1/4"	4
TAK7-3	1 1/4"	4
TAK7-4	1 1/4"	4
TAK7-5	1 1/4"	4
TAK7-6	1 1/4"	4
TAK7-7	1 1/4"	4
TAK7-8	1 1/4"	4
TAK7-9	1 1/4"	4
TAK7-10	1 1/4"	4
TAK7-11	1 1/4"	4
TAK7-12	1 1/4"	4

► AUTOMATIC AIR VENTIL



CODE	SIZE	BOX
451	1/2"	50
451-1	1/4"	100

► MECHANICAL AIR VENTIL



CODE	SIZE	POŞET
450	1/4"	100

► RELIEF VALVE FOR MANIFOLD



CODE	SIZE	BOX
600	1"	65
601	1 1/4"	50
602	1"	50
603	1 1/4"	50
602-1	1"	65
603-1	1 1/4"	50

▶ VALVE WITH ACTUATOR CONNECTION & FITTING



CODE	SIZE	BOX
118AV	1"	20

▶ ROOM THERMOSTAT



CODE	SIZE	BOX
579-1	220V Mechanic	25
579-13	220V Digital	25

▶ NUT + RING + HOSE TIP



CODE	SIZE	BOX
U-HOR-01	3/4" (16x2)	160
U-HOR-02	3/4" (17x2)	160
U-HOR-03	3/4" (20x2)	100

▶ MALE STOPPER - YELLOW



CODE	SIZE	BOX
840	1/2" DN15	500
841	3/4" DN20	400
842	1" DN25	250
843	1 1/4" DN32	200
844	1 1/2" DN40	100
845	2" DN50	75
846	2 1/2" DN65	50

▶ FEMALE STOPPER - NICKEL PLATED



CODE	SIZE	BOX
850	1/2" DN15	500
851	3/4" DN20	400
852	1" DN25	250
853	1 1/4" DN32	200
854	1 1/2" DN40	100
855	2" DN50	75
856	2 1/2" DN65	50

▶ ELECTROTHERMAL ACTUATOR



CODE	SIZE	BOX
579-21	220V Indicative	25

▶ WIRING BOX FOR THERMOSTATIC MANIFOLD



CODE	SIZE	BOX
579-3	220V 8 Input	10

▶ Y- STRAINER (YELLOW)



CODE	SIZE	BOX
220	1/2" DN15	100
221	3/4" DN20	60
222	1" DN25	30
223	1¼" DN32	18
224	1½" DN40	10
225	2" DN50	8
226	2½" DN65	6
227	3" DN80	4
228	4" DN100	2

▶ TEST NIPPLE FOR GAS



CODE	SIZE	BOX
971	1/8"- Short	1000
972	1/8"- Long	1000

▶ BATARYA TERMİNAL DİRSEK



CODE	SIZE	BOX
460	1/2"- 16x2	24

► ELBOW (MALE-FEMALE)



CODE	SIZE	BOX
895	1/8" DN6	150
896	1/4" DN8	150
897	3/8" DN10	150
898	1/2" DN15	150
899	3/4" DN20	100
900	1" DN25	50
901	1 1/4" DN32	35

► ELBOW (FEMALE)



CODE	SIZE	BOX
885	1/8" DN6	150
886	1/4" DN8	150
887	3/8" DN10	150
888	1/2" DN15	150
889	3/4" DN20	100
890	1" DN25	50
891	1 1/4" DN32	25
892	1 1/2" DN40	20
893	2" DN50	12

► TEE- FEMALE



CODE	SIZE	BOX
875	1/8" DN6	100
876	1/4" DN8	100
877	3/8" DN10	100
878	1/2" DN15	100
879	3/4" DN20	75
880	1" DN25	50
881	1 1/4" DN32	20
882	1 1/2" DN40	20
883	2" DN50	15

► BRASS SCREW BARRELS (FEMALE)



CODE	SIZE	BOX
935	1/8" DN6	100
936	1/4" DN8	100
937	3/8" DN10	100
938	1/2" DN15	100
939	3/4" DN20	100
940	1" DN25	100
941	1 1/4" DN32	50
942	1 1/2" DN40	50
943	2" DN50	25

► RESERVE REDUCER (MALE-FEMALE)



CODE	SIZE	BOX
925	1/4"-1/8"	200
926	3/8"-1/4"	200
927	1/2"-1/4"	200
928	1/2"-3/8"	250
929	3/4"-1/2"	250
930	1"-1/2"	150
931	1"-3/4"	150

► PROPORIAL NIPPLE (MALE)



CODE	SIZE	BOX
860	1/4"-1/8"	400
861	3/8"-1/8"	400
862	3/8"-1/4"	400
863	1/2"-1/4"	400
864	1/2"-3/8"	400
865	3/4"-1/2"	250
866	1"-1/2"	150
867	1"-3/4"	150
868	1 1/4"-1"	75
869	1 1/2"-1 1/4"	50

► NIPPLE



CODE	SIZE	BOX
NİPEL - NİKEL		
907	3/8" DN10	400
432	1/2" DN15	400
433	3/4" DN20	250
434	1" DN25	150
435	1 1/4" DN32	75
435-1	1 1/2" DN40	50
435-2	2" DN50	50

CODE	SIZE	BOX
NİPEL - SARI		
907-1	3/8" DN10	400
437	1/2" DN15	400
438	3/4" DN20	250
439	1" DN25	150
440	1 1/4" DN32	75
440-1	1 1/2" DN40	50
440-2	2" DN50	50

► REDUCER



CODE	SIZE	BOX
1100	1/4"-1/8"	250
1101	3/8"-1/8"	250
1102	3/8"-1/4"	250
1103	1/2"-1/8"	250
1104	1/2"-1/4"	250
1105	1/2"-3/8"	250
1106	3/4"-3/8"	250
505	3/4"-1/2"	300
506	1"-3/4"	200
507	1 1/4"-1"	125
508	1 1/2"-1 1/4"	50
508-1	1 1/2"-1"	50
509	2"-1 1/2"	50
510	2 1/2"-2"	25

▶ MALE FITTING FOR HOSE



CODE	SIZE
985	1/8" - 6 mm
985-1	1/8" - 8 mm
985-2	1/8" - 10 mm
985-3	1/8" - 12 mm
986	1/4" - 6 mm
986-1	1/4" - 8 mm
986-2	1/4" - 10 mm
986-3	1/4" - 12 mm
987	3/8" - 6 mm
987-1	3/8" - 8 mm
987-2	3/8" - 10 mm
987-3	3/8" - 12 mm
987-4	3/8" - 16 mm
988	1/2" - 6 mm
988-1	1/2" - 8 mm
988-2	1/2" - 10 mm
988-3	1/2" - 12 mm
989	1/2" - 16 mm
989-1	1/2" - 20 mm
990	3/4" - 8 mm
990-1	3/4" - 10 mm
990-2	3/4" - 12 mm
990-3	3/4" - 16 mm
991	3/4" - 20 mm
992	3/4" - 27 mm
993	1" - 27 mm
994	1" - 33 mm
995	1 1/4" - 40 mm
996	1 1/2" - 40 mm
997	1 1/4" - 32 mm

▶ WATER COUNTER FITTINGS (SET-2 PCS.)



CODE	SIZE	BOX
521	1/2" DN15	100 Tk.
520	3/4" DN20	100 Tk.

▶ FEMALE STOPPER

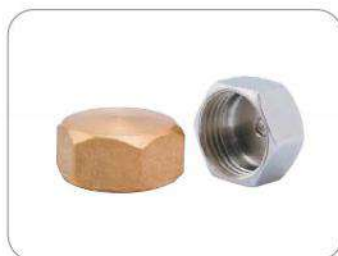

CODE	SIZE	BOX
965	3/8" DN10	400
966	1/2" DN15	500
967	3/4" DN20	400
968	1" DN25	250
969	1 1/4" DN32	150
970	1 1/2" DN40	100

▶ FAUCET JOINT - CHROME PLATED



CODE	SIZE	BOX
------	------	-----

(1/2")

619	0.5 cm	500
620	1 cm	500
621	1.5 cm	400
622	2 cm	300
623	2.5 cm	250
624	3 cm	250
625	4 cm	200
626	5 cm	150

(3/4")

635	1 cm	400
636	1.5 cm	300
637	2 cm	200
638	2.5 cm	150
639	3 cm	150

627	1/2"-3/4"	250
629	3/4"-1/2"-3/4"	100
630	3/4"	100
631	1/2"-1/2"-1/2"	100
628	3/4"	75

▶ PUMPER FITTINGS (SET-2 PCS.)



CODE	SIZE	BOX
------	------	-----

526-3	1" DN25	20 Tk.
526-4	1 1/4" DN32	20 Tk.

► G4 NATURAL GAS METER SET



CODE	BOX
G4-01	10 Tk.

► G4 NATURAL GAS METER CONSOLE



CODE	BOX
G4-03	100

► FLEXIBLE GAS HOSE (MALE-FEMALE - EN 14800)



CODE	ÇAP	SIZE	BOX
1/2" MALE - 1/2" FEMALE			
FL-270	1/2"-1/2"	50 cm	25
FL-271	1/2"-1/2"	75 cm	25
FL-272	1/2"-1/2"	100 cm	25
FL-273	1/2"-1/2"	125 cm	25
FL-274	1/2"-1/2"	150 cm	25
FL-275	1/2"-1/2"	200 cm	25

► FAN-COILER FLEXIBLE HOSE 1/2" MALE - 1/2" FEMALE



CODE	SIZE	BOX
FS-2900	20 cm	40
FS-2910	30 cm	40
FS-2920	40 cm	20
FS-2930	50 cm	20
FS-2940	60 cm	20
FS-2950	70 cm	20
FS-2960	80 cm	20

► GAS ALARM - 220 V



CODE	BOX
G-001	50

► G4 NATURAL GAS METER FLEX



CODE	BOX
G4-02	25

► G4 NATURAL GAS METER FITTING (SET-2 PCS.)



CODE	ÇAP	SIZE	BOX
G4-04	1" DN32	1	50

► FLEXIBLE GAS HOSE (WITH MAKARON)



CODE	ÇAP	SIZE	BOX
3/4" MALE - 3/4" FEMALE			
FL-230	3/4"-3/4"	30 cm	25
FL-231	3/4"-3/4"	40 cm	25
FL-232	3/4"-3/4"	50 cm	25
FL-233	3/4"-3/4"	60 cm	25
FL-234	3/4"-3/4"	70 cm	25

► FAN-COILER FLEXIBLE HOSE 3/4" MALE - 3/4" FEMALE



CODE	SIZE	BOX
FS-2800	20 cm	30
FS-2810	30 cm	30
FS-2820	40 cm	15
FS-2830	50 cm	15
FS-2840	60 cm	15
FS-2850	70 cm	15
FS-2860	80 cm	15

► PRESSURE REGULATOR



CODE	SIZE	BOX
800-1	1/2" DN15	20
800-2	3/4" DN20	20
800-3	1" DN25	20
800-4	1¼" DN32	10
800-5	1½" DN40	10
800-6	2" DN50	10

► MANOMETER



CODE	SIZE	BOX
818	Bottom Out	20
819	Back Out	20

► BIDET NOZZLE WITH FILTER



CODE	SIZE	BOX
NICKEL PLATED		
209-6	1/2" - 3/8"	75
209-66	1/2" - 1/2"	75
CHROME PLATED		
209-5	1/2" - 3/8"	75
209-55	1/2" - 1/2"	75

► SPHERICAL BIBCOCK WITH T-HANDLE



CODE	SIZE	BOX
209-2	1/2" DN15	50
209-3	3/4" DN20	50

▶ PRESSURE REGULATOR WITH FITTINGS



CODE	SIZE	BOX
801-01	1/2" DN15	20
801-02	3/4" DN20	20

▶ WASHING MACHINE CONNECTION VALVE



CODE	SIZE	BOX
NICKEL PLATED		
209-8	1/2" - 3/4"	75
CHROME PLATED		
209-88	1/2" - 3/4"	75

▶ IRON SHEET METAL FOR MIXER ELBOW

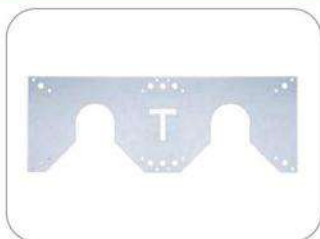

CODE	SIZE	BOX
461		100

▶ SOCKET WELDED RADIATOR PIPE



CODE	SIZE	BOX
446	40 cm	100
446-1	50 cm	100
446-2	60 cm	100
446-3	90 cm	50

▶ PIPE WITH "S" (16X2)



CODE	SIZE	BOX
445	40 cm	100
445-1	50 cm	100
445-2	60 cm	100
445-3	90 cm	50

▶ RADIATOR VALVE (15 mm)



CODE	SIZE	BOX
444-5	40 cm	100
444-6	50 cm	100
444-7	60 cm	100
444-8	90 cm	50

▶ MANIFOLD CABINET WITH FRAME



CODE	SIZE
454	40x70x11 cm (2-3-4-5)
455	60x70x11 cm (6-7-8-9)
456	80x70x11 cm (10-11-12)

▶ MANIFOLD CABINET



CODE	SIZE
457	40x60x11 cm (2-3-4-5)
458	60x60x11 cm (6-7-8-9)
459	80x60x11 cm (10-11-12-13)
459-01	100x60x11 cm (14-15-16-17)

► RADIATOR PIPE WITH ELBOW (16X2)



CODE	SIZE	BOX
446-6	40 cm	100
446-7	50 cm	100
446-8	60 cm	100
446-9	90 cm	50

► PIPE WITH NIPPLE (1/2" - 15 mm)



CODE	SIZE	BOX
445-5	40 cm	100
445-6	50 cm	100
445-7	60 cm	100
445-8	90 cm	50

► ELBOW FOR RADIATOR CONNECTION (10 cm)



CODE	SIZE	BOX
447	1/2"-16x2	250

► LONG ELBOW FOR RADIATOR CONNECTION



CODE	SIZE	BOX
447-2	1/2"-16x2	100

► MANIFOLD CLAMPS - SET 2 PCS.



CODE	SIZE	BOX
452	1" DN25	25 tk
453	1 1/4" DN32	25 tk

► KÜRESEL VANA ÇELİK KULP



CODE	SIZE
------	------

KULP 01	1/2"-3/4"-1"
KULP 02	1 1/4" - 1 1/2"
KULP 03	2"

► KÜRESEL KELEBEK KULP



CODE	SIZE
------	------

KULP 04	1/2"-3/4"
KULP 05	1"
KULP 06	1 1/4"

► MİNİ KÜRESEL KULP



CODE	SIZE
------	------

KULP 07	1/2"
---------	------

► RADYATÖR VANA VOLANI



CODE	SIZE
------	------

KULP 08	1/2"-3/4"
---------	-----------

► SOMUN-YÜZÜK-HORTUM UCU



CODE	SIZE
------	------

SOMUN	16 x 2
YÜZÜK	16 x 2
HORTUM UCU	16 x 2

► KENDİNDEN VANALI KOLLEKTÖR VOLANI



CODE SIZE

KULP 025

► KOLLEKTÖR DEBİMETRESİ



CODE SIZE

SALMASTRA 006

► KOLLEKTÖR DEBİMETRESİ



CODE SIZE

BOBİN 001

► MASURA VE SOMUN



CODE SIZE

MS01 1/2"

MS02 1"

Avrasia

Plumbing
Materials



plastherm

Quality Standards

Quality Standards

In accordance with our company objectives, our quality management in conformity with DIN ISO 9001 is mainly directed towards our customers and the market. Our inner factory quality standards include raw material testing, production survey, and testing of end products as prescribed in DIN standards.

Tests are conducted continuously in our own laboratory, guaranteeing maximum safety. All results are filed to provide the proceeding surveys and individual data measurement.

We also get the collaboration of the independent testing institutes to ensure that our products fit well with the other applicable specifications like DIN, O-Norm and ISO and that their quality remains at a constant high level.

All pipes and fittings produced in our factory undergo the following tests:

- Melting index test of raw materials
- Testing the accuracy of dimensions and surface nature
- Interior long-term pressure test of 1 hour at 20°C and up to 80 bar depending on the nominal pressure degree
- Notched bar impact test
- Thermal test
- Welding index of processed materials
- Microscopic examination
- Continuous tube sheet thickness survey and measurement

Samples of all feeds are submitted to a long-term internal pressure test lasting 1000 hours at 95°C and up to 18 bar.

It is our objective to carry out practice-oriented problem solving, by applying scientific methods and by satisfying our customers by quality and dependable delivery.



plastherm®

Long-term Behaviour / Durability

Long-term Behaviour / Durability

By means of the long-term internal pressure diagram and the given formula for determination of the reference tension, it is rather simple to determine the durability.

$$\sigma_v = \frac{P(d_a - S)}{2S}$$

Explanation of the formula:

σ_v = reference tension [N/mm²]
 P = internal pressure [N/mm²]
 d_a = external diameter of the pipe [mm]
 S = wall thickness of the pipe [mm]

Applicable:

1 bar = 0.1 N/mm²

Example :

Tube employed 20 X 3.4, nominal pressure degree PN 20, operational pressure 10 bar. The resulting reference tension will be:

$$\sigma_v = 1 \text{ N/mm}^2 \cdot \frac{(20 \text{ mm} - 3.4 \text{ mm})}{6.8 \text{ mm}}$$

If the reference tension is drawn as a straight line in the long-term internal pressure diagram and is caused to intersect with the isotherms of the corresponding operating temperature, the durability of the pipe to be anticipated in hours will result from the projection onto the X-axis.

In general, however, no point of intersection is reached under the operating conditions encountered in practice. Life > 50 years.

Calculating of security factor SF:

σ_v (for instance 50 years 60° C) = 4.9 N/mm² established from the diagram. It becomes clear that Plastherm pipes present tremendous safety margins in real application situations.

In the planning phase, it is customary to start from the peak temperatures to be anticipated; if we take into account the operational temperatures, which in most cases are considerably lower, and their effective periods, the safety margin is even higher.

plastherm®

Behaviour under long term stress

Behaviour under long term stress

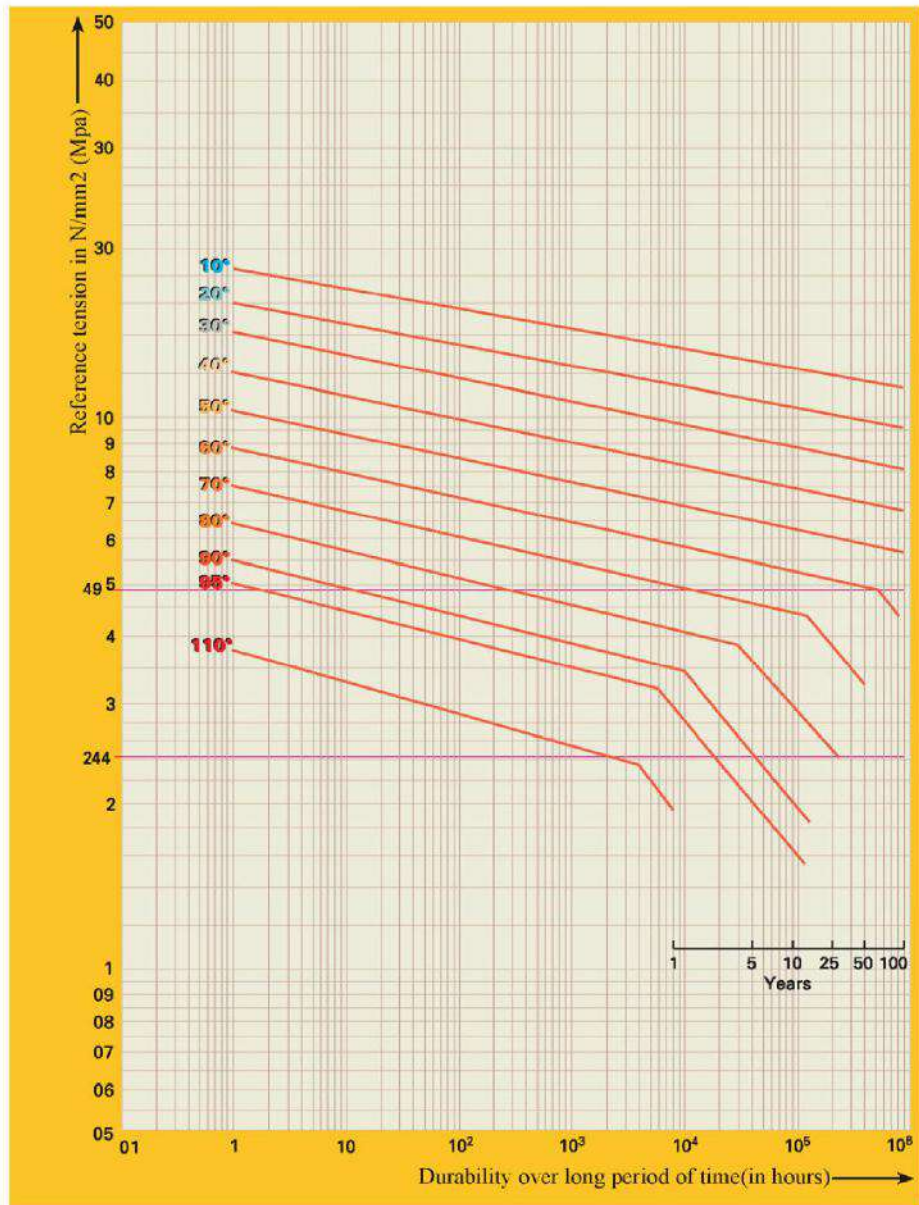

Elongation and Bending

The following items need to be taken into consideration when calculating modifications in length:

- Ambient and materials temperature upon installation
- Temperature difference between the lowest and the highest pipe wall temperatures
 - Expansion coefficient
- The formula for the calculation of length alterations is as follows:

$$\Delta L = \alpha \cdot L \cdot \Delta T$$

Explanation:

ΔL = Length alteration in mm

α = Expansion coefficient in K^{-1}
 polypropilene pipes $\alpha = 0.15$,
 prostab AL/PPR composite pipes
 $\alpha = 0.05$

L = Pipe length in (m)

ΔT = Difference in temperatures in K

Pipe length = 4 m	Temperature range
Pipe wall temperature	60° C
Temp, at installation	15° C
Difference in temp	45 K

$$\Delta L_2 = 0.15 \times 4 \times 45 = 27.00 \text{ mm}$$

The alteration of length may be compensated by means of extension loops, bending legs, extension bows or appropriate adapters.

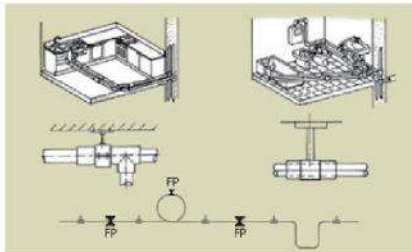

Extension bows

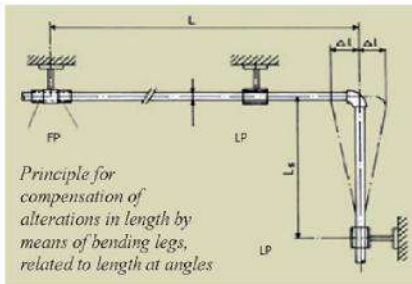

Principle for compensation of alterations in length by means of bending legs, related to length at angles

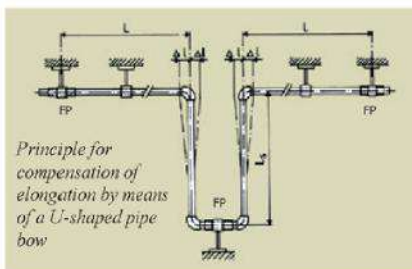

Principle for compensation of elongation by means of a U-shaped pipe bow

FP = Fixing point

LS = Length of bending leg

L = Length of pipe

LP = Gliding rail

$$\Delta L = \Delta L_1 + \Delta L_2$$

The minimum length of the bending leg results from:

$$L_s = K \cdot \sqrt{d \cdot \Delta L}$$

Explanation:

L_s = Length of bending leg in mm

K = Constant depending on material (K value for PP = 15)

d = Pipe diameter in mm

Δ = Elongation in mm, calculated by equation

$$\Delta L = \alpha \cdot L \cdot \Delta T$$

Vide also following example of graphic and mathematical determination of the bending leg.

plastherm®

Application areas

Application areas:

1. Heating and water supply installations of residential buildings and offices.
2. Hot and cold water pipe installations.
3. Industrial, urban water-supply, and agricultural water installations
4. Passenger compartments on ships and trains



CAUTION!

1. Protect the pipes from direct impact
2. Don't expose them to sunlight for a long time
3. For bending don't use fire on the pipes, but only industrial air-blower where the temperature of the air-stream is no more that 140° C
4. While loading the pipes on a vehicle do not bend them



plastherm®

Welding Instructions

The quality and the life span of any pipe installation depends equally on both the geometric accuracy and the weldings. Connecting pipes and fittings through melting takes just a few seconds. After a few minutes the welded pipe installation is ready to be installed.



You cut the pipe, heat the fitting with the welding machine and then connect the two parts. That's all Fast, without substantial efforts and with wonderful result.

All welded connections are completely safe because when the polypropilene cools down there's no change in its structure, shape or durability.



Instructions for welding pipes and fittings

1. Choose the appropriate detail and put it on the welding machine.
2. Turn on the welding machine. Wait until the two control indicators are heating. When the device is ready for use the indicator turns off. This means that the necessary temperature has been reached /260° C ± 10° C/
3. Attach properly the end of the pipe and the fitting to the welding device.
4. If the pipe or the fitting is dirty clean it with water and alcohol solution.
5. Then heat equally for the duration of few seconds both the pipe and the fitting. Then connect them and leave them for a few minutes to cool down so that the welding be successful.
6. The necessary heating time, welding time and cool-down time for each corresponding pipe diameter is shown in the following table.



External pipe diameter mm	Insert depths mm	Heating period secs	Processing period secs	Cooling period mins
16	13	5		
20	14	5	4	2
25	15	7		
32	16,5	8		
40	18	12	6	4
50	20	18		
63	24	24	8	6
75	26	30	10	8

plastherm®

We assure and confirm that all PPR-C Fittings have been produced by PN20-PN25



PIPE PN 20 (20 ATU)			
Code	Size	Packing	
P0102001	20x3,4 mm	100	
P0102501	25x4,2 mm	100	
P0103201	32x5,4 mm	60	
P0104001	40x6,7 mm	40	
P0105001	50x8,4 mm	20	
P0106301	63x10,5 mm	16	
P0107501	75x12,5 mm	12	
P0109001	90x15,0 mm	8	
P0111001	110x18,4 mm	4	
P0112501	125x20,9 mm	4	



PP FIBER GLASS PP (PN 25)			
Code	Size	Packing	
P0402001	20x3,4 mm	100	
P0402501	25x4,2 mm	100	
P0403201	32x5,4 mm	60	
P0404001	40x6,7 mm	40	
P0405001	50x8,4 mm	20	
P0406301	63x10,5 mm	16	
P0407501	75x12,5 mm	12	
P0409001	90x15,0 mm	8	
P0411001	110x18,4mm	4	
P0412501	125x20,9 mm	4	



PIPE PN 16 (16 ATU)			
Code	Size	Packing	
P0202001	20x2,8 mm	100	
P0202501	25x3,5 mm	100	
P0203201	32x4,4 mm	60	
P0204001	40x5,5 mm	40	
P0205001	50x6,9 mm	20	
P0206301	63x8,6 mm	16	
P0207501	75x10,3 mm	12	
P0209001	90x12,3 mm	8	
P0211001	110x15,1 mm	4	
P0212501	125x17,1 mm	4	



PP FIBER GLASS PP (PN 20)			
Code	Size	Packing	
P0502001	20x2,8 mm	100	
P0502501	25x3,5 mm	100	
P0503201	32x4,4 mm	60	
P0504001	40x5,5 mm	40	
P0505001	50x6,9 mm	20	
P0506301	63x8,6 mm	16	
P0507501	75x10,3 mm	12	
P0509001	90x12,3 mm	8	
P0511001	110x15,1mm	4	
P0512501	125x17,1 mm	4	



PIPE PN 10 (10 ATU)			
Code	Size	Packing	
P0302001	20x1,9 mm	100	
P0302501	25x2,3 mm	100	
P0303201	32x3,0 mm	60	
P0304001	40x3,7 mm	40	
P0305001	50x4,6 mm	20	
P0306301	63x5,8 mm	16	
P0307501	75x6,9 mm	12	
P0309001	90x8,2 mm	8	
P0311001	110x10,0 mm	4	
P0312501	125x11,4 mm	4	



STABLE PIPE PN 25 (25 ATU)			
Code	Size	Packing	
P0602001	20x3,4 mm	100	
P0602501	25x4,2 mm	100	
P0603201	32x5,4 mm	60	
P0604001	40x6,7 mm	40	
P0605001	50x8,4 mm	20	
P0606301	63x10,5 mm	16	
P0607501	75x12,5 mm	12	

plastherm®

We assure and confirm that all PPR-C Fittings have been produced by PN20-PN25



SOCKET, EQUAL			
Code	Size	Packing	
P0702001	20 mm	500	
P0702501	25 mm	320	
P0703201	32 mm	150	
P0704001	40 mm	100	
P0705001	50 mm	60	
P0706301	63 mm	32	
P0707501	75 mm	24	
P0709001	90 mm	16	
P0711001	110 mm	10	
P0712501	125 mm	6	



REDUCER			
Code	Size	Packing	
P0802501	25/20	500	
P0803201	32/20	300	
P0803202	32/25	300	
P0804001	40/20	200	
P0804002	40/25	200	
P0804003	40/32	160	
P0805001	50/20	100	
P0805002	50/25	100	
P0805003	50/32	100	
P0805004	50/40	100	
P0806301	63/20	60	
P0806302	63/25	60	
P0806303	63/32	60	
P0806304	63/40	60	
P0806305	63/50	40	
P0807501	75/20	50	
P0807502	75/25	50	
P0807503	75/32	40	
P0807504	75/40	40	
P0807505	75/50	40	
P0807506	75/63	32	
P0809001	90/32	40	
P0809002	90/40	40	
P0809003	90/50	20	
P0809004	90/63	20	
P0809005	90/75	20	
P0811001	110/40	20	
P0811002	110/50	20	
P0811003	110/63	16	
P0811004	110/75	15	
P0811005	110/90	10	
P0812504	125/75	12	
P0812505	125/90	12	
P0812506	125/110	8	



REDUCTION ELBOW 90°			
Code	Size	Packing	
P1002001	20x25 mm	250	



ELBOW 90°			
Code	Size	Packing	
P0902001	20 mm	400	
P0902501	25 mm	200	
P0903201	32 mm	100	
P0904001	40 mm	75	
P0905001	50 mm	40	
P0906301	63 mm	20	
P0907501	75 mm	12	
P0909001	90 mm	8	
P0911001	110 mm	3	
P0912501	125 mm	2	



CROSSOVER PIPE			
Code	Size	Packing	
P1102001	20 mm	80	
P1102501	25 mm	50	
P1103201	32 mm	30	



CROSSOVER WITH SOCKET			
Code	Size	Packing	
P1202001	20 mm	75	
P1202501	25 mm	70	
P1203201	32 mm	40	



SOCKET WELD IN SADDLE (SHORT)			
Code	Size	Packing	
P1302001	20 mm	150	
P1302501	25 mm	120	
P1303201	32 mm	60	



SOCKET WELD IN SADDLE			
Code	Size	Packing	
P2202501	25 mm (For 75 mm)	250	



PLUG FOR REHEARSAL TESTS			
Code	Size	Packing	
P2602001	20 mm	300	

plastherm®

We assure and confirm that all PPR-C Fittings have been produced by PN20-PN25



TEE 90° REDUCING			
Code	Size	Packing	
P1702001	20x25x20	160	
P1702501	25x20x20	160	
P1702502	25x20x25	160	
P1702503	25x25x20	160	
P1702505	25x32x25	100	
P1703201	32x20x20	100	
P1703202	32x20x25	100	
P1703203	32x20x32	100	
P1703204	32x25x20	100	
P1703205	32x25x25	100	
P1703206	32x25x32	100	
P1703207	32x32x20	100	
P1703208	32x32x25	100	
P1703211	32x40x32	50	
P1703214	32x50x32	50	
P1704004	40x20x40	50	
P1704007	40x25x32	50	
P1704008	40x25x40	50	
P1704012	40x32x40	50	
P1704019	40x50x40	40	
P1705005	50x20x50	30	
P1705010	50x25x50	30	
P1705013	50x32x32	32	
P1705014	50x32x40	32	
P1705015	50x32x50	30	
P1705018	50x40x32	32	
P1705019	50x40x40	32	
P1705020	50x40x50	30	
P1705023	50x50x32	30	
P1705024	50x50x40	30	
P1706306	63x20x63	20	
P1706312	63x25x63	20	
P1706318	63x32x63	20	
P1706324	63x40x63	20	
P1706330	63x50x63	20	
P1707507	75x20x75	10	
P1707514	75x25x75	10	
P1707521	75x32x75	10	
P1707528	75x40x75	10	
P1707535	75x50x75	10	
P1707542	75x63x75	10	
P1709024	90x32x90	5	



TEE 90° REDUCING			
Code	Size	Packing	
P1709032	90x40x90	5	
P1709040	90x50x90	5	
P1709048	90x63x90	5	
P1709056	90x75x90	5	
P1711036	110x40x110	3	
P1711045	110x50x110	3	
P1711054	110x63x110	3	
P1711063	110x75x110	3	
P1711072	110x90x110	2	
P1712570	125x75x125	2	
P1712580	125x90x125	2	
P1712590	125x110x125	2	

CROSS TEE			
Code	Size	Packing	
P1402001	20 mm	150	
P1402501	25 mm	100	
P1403201	32 mm	60	
P1404001	40 mm	40	

FEMALE THREADED CROSS TEE			
Code	Size	Packing	
P2705001	50x1/2"x50x1/2"	32	
P2705002	50x3/4"x50x3/4"	32	
P2706301	63x1/2"x63x1/2"	20	
P2706302	63x3/4"x63x3/4"	20	

ELBOW 45°			
Code	Size	Packing	
P1502001	20 mm	400	
P1502501	25 mm	250	
P1503201	32 mm	150	
P1504001	40 mm	80	
P1505001	50 mm	40	
P1506301	63 mm	20	
P1507501	75 mm	12	
P1509001	90 mm	5	
P1511001	110 mm	3	
P1512501	125 MM	2	

plastherm®

We assure and confirm that all PPR-C Fittings have been produced by PN20-PN25



TEE 90°			
Code	Size	Packing	
P1602001	20 mm	250	
P1602501	25 mm	150	
P1603201	32 mm	60	
P1604001	40 mm	50	
P1605001	50 mm	30	
P1606301	63 mm	14	
P1607501	75 mm	10	
P1609001	90 mm	5	
P1611001	110 mm	2	
P1612501	125 mm	2	



FEMALE DOUBLE BATTERY CONNECTION			
Code	Size	Packing	
P3002001	20x1/2"	40	
P3002501	25x1/2"	40	



MALE DOUBLE BATTERY CONNECTION			
Code	Size	Packing	
P3502001	20x1/2"	40	
P3502501	25x1/2"	40	



END CAP			
Code	Size	Packing	
P1802001	20 mm	500	
P1802501	25 mm	500	
P1803201	32 mm	300	
P1804001	40 mm	160	
P1805001	50 mm	100	
P1806301	63 mm	50	
P1807501	75 mm	32	
P1809001	90 mm	24	
P1811001	110 mm	10	



DOUBLE BIDET CONNECTION			
Code	Size	Packing	
P3602001	20X1/2 mm	40	
P3602501	25X1/2 mm	40	



FEMALE THREADED BATTERY BYPASS			
Code	Size	Packing	
P3102001	20x1/2"	100	
P3102501	25x1/2"	100	



FEMALE THREADED BATTERY CONNECTION			
Code	Size	Packing	
P2802001	20x1/2"	120	
P2802501	25x1/2"	120	
P2802502	25x3/4"	100	



MALE THREADED BATTERY BYPASS			
Code	Size	Packing	
P3302001	20x1/2"	120	
P3302501	25x1/2"	120	



MALE THREADED BATTERY CONNECTION			
Code	Size	Packing	
P3402001	20x1/2"	100	
P3402501	25x1/2"	100	
P3402502	25x3/4"	100	



PPRC INNER FLANGE			
Code	Size	Packing	
P5907501	75 mm	40	
P5909001	90 mm	25	
P5911001	110 mm	15	
P5912501	125 mm	8	



FEMALE ADJUSTABLE BATTERY			
Code	Size	Packing	
P2902001	20x1/2"	24	
P2902501	25x1/2"	24	



MALE ADJUSTABLE BATTERY			
Code	Size	Packing	
P3202001	20x1/2"	24	
P3202501	25x1/2"	24	



PPRC OUTER FLANGE			
Code	Size	Packing	
P6106301	63 MM	35	
P6107501	75 MM	26	
P6109001	90 MM	22	
P6111001	110 MM	18	
P6112501	125 MM	15	

plastherm®

We assure and confirm that all PPR-C Fittings have been produced by PN20-PN25



ADAPTOR FEMALE THREADED			
Code	Size	Packing	
P3702001	20x1/2"	200	
P3702002	20x3/4"	150	
P3702501	25x1/2"	150	
P3702502	25x3/4"	150	
P3703201	32x1/2"	100	
P3703202	32x3/4"	100	
P3703203	32x1"	80	



ELBOW 90° FEMALE THREADED			
Code	Size	Packing	
P4102001	20x1/2"	200	
P4102002	20x3/4"	150	
P4102501	25x1/2"	150	
P4102502	25x3/4"	150	
P4103201	32x1/2"	50	
P4103202	32x3/4"	50	
P4103203	32x1"	50	



HEXAGONAL ADAPTOR FEMALE THREADED			
Code	Size	Packing	
P3803203	32x1"	80	
P3804004	40x1 1/4"	40	
P3805005	50x1 1/2"	40	
P3806306	63x2"	20	
P3807507	75x2 1/2"	15	
P3809008	90x3"	8	
P3811009	110x4"	5	
P3812510	125x5"	2	



ELBOW 90° MALE THREADED			
Code	Size	Packing	
P4302001	20x1/2"	160	
P4302002	20x3/4"	100	
P4302501	25x1/2"	100	
P4302502	25x3/4"	100	
P4303201	32x1/2"	50	
P4303202	32x3/4"	50	
P4303203	32x1"	50	



ADAPTOR MALE THREADED			
Code	Size	Packing	
P3902001	20x1/2"	200	
P3902002	20x3/4"	100	
P3902501	25x1/2"	150	
P3902502	25x3/4"	150	
P3903201	32x1/2"	100	
P3903202	32x3/4"	100	
P3903203	32x1"	80	



TEE 90° FEMALE THREADED			
Code	Size	Packing	
P4402001	20x1/2"x20	160	
P4402002	20x3/4"x20	100	
P4402501	25x1/2"x25	100	
P4402502	25x3/4"x25	100	
P4403201	32x1/2"x32	50	
P4403202	32x3/4"x32	50	
P4403203	32x1"x32	50	
P4404002	40x3/4"x40	50	
P4404003	40x1 1/4"x40	40	
P4405001	50x1/2"x50	50	
P4405002	50x3/4"x50	40	
P4406301	63x1/2"x63	20	
P4406302	63x3/4"x63	20	



HEXAGONAL ADAPTOR MALE THREADED			
Code	Size	Packing	
P4003203	32x1"	80	
P4004004	40x1 1/4"	40	
P4005005	50x1 1/2"	32	
P4006306	63x2"	16	
P4007507	75x2 1/2"	12	
P4009008	90x3"	8	
P4011009	110x4"	5	
P4012510	125x5"	2	



TEE 90° MALE THREADED			
Code	Size	Packing	
P4602001	20x1/2"x20	150	
P4602002	20x3/4"x20	100	
P4602501	25x1/2"x25	100	
P4602502	25x3/4"x25	100	
P4603201	32x1/2"x32	50	
P4603202	32x3/4"x32	50	
P4603203	32x1"x32	50	

plastherm®

We assure and confirm that all PPR-C Fittings have been produced by PN20-PN25



FEMALE FILTER			
Code	Size	Packing	
P5302001	20 mm	150	
P5302501	25 mm	70	
P5303201	32 mm	50	



MALE FILTER			
Code	Size	Packing	
P5402001	20 mm	100	
P5402501	25 mm	70	
P5403201	32 mm	50	



NIPPLE WITH LOOSE NUT			
Code	Size	Packing	
P5502001	20x1/2"	200	
P5502002	20x3/4"	150	
P5502502	25x3/4"	150	
P5502503	25x1"	80	
P5503203	32x1"	80	
P5503204	32x1 1/4"	80	



ELBOW WITH LOOSE NUT			
Code	Size	Packing	
P5602001	20x1/2"	200	
P5602002	20x3/4"	150	
P5602502	25x3/4"	150	
P5602503	25x1"	100	
P5603203	32x1"	80	
P5603204	32x1 1/4"	80	



TEE WITH LOOSE NUT			
Code	Size	Packing	
P5702001	20x1/2"	150	
P5702002	20x3/4"	150	
P5702502	25x3/4"	100	
P5702503	25x1"	100	
P5703203	32x1"	80	
P5703204	32x1 1/4"	80	



VALVE CHROMEPLATED			
Code	Size	Packing	
P6302001	20x1/2"	20	
P6302002	20x3/4"	20	
P6302502	25x3/4"	20	
P6303203	32x1"	20	



CONCEALED VALVE			
Code	Size	Packing	
P5802002	20-3/4"	30	
P5802502	25-3/4"	30	



VALVE BOTTOM			
Code	Size	Packing	
P6502001	20x1/2"	100	
P6502002	20x3/4"	100	
P6502502	25x3/4"	100	
P6503202	32x3/4"	50	
P6503203	32x1"	50	



MALE PLUG SHORT			
Code	Size	Packing	
P2002001	20x1/2"	800	
P2002501	25x3/4"	500	
P2003201	32x1"	500	



MALE PLUG TALL			
Code	Size	Packing	
P2102001	20x1/2"	600	



DOUBLE BARACELET			
Code	Size	Packing	
P2302001	20 mm	400	
P2302501	25 mm	300	
P2303201	32 mm	200	



BRACELET			
Code	Size	Packing	
P1902001	20 mm	1200	
P1902501	25 mm	800	
P1903201	32 mm	500	
P1904001	40 mm	300	
P1905001	50 mm	100	
P1906301	63 mm	100	



BRACELET WITH COVER			
Code	Size	Packing	
P2402001	20 mm	600	
P2402501	25 mm	500	
P2403201	32 mm	300	
P2404001	40 mm	200	
P2405001	50 mm	100	
P2406301	63 mm	100	

plastherm®

We assure and confirm that all PPR-C Fittings have been produced by PN20-PN25



ADAPTOR UNION PP/BRASS MALE THREADED			
Code	Size	Packing	
P4902001	20x1/2"	200	
P4902502	25x3/4"	100	
P4902503	25X1"	100	
P4903203	32x1"	80	
P4904004	40x1 1/4"	40	
P4905005	50x1 1/2"	32	
P4906306	63x2"	16	
P4907507	75x2 1/2"	12	
P4909008	90x3"	5	



STRAIGHT VALVULA			
Code	Size	Packing	
P6201201	1/2"	80	
P6203401	3/4"	80	
P6200101	1"	100	
P6211401	1 1/4"	60	



CROMED UPPER PART			
Code	Size	Packing	
P6703401	3/4"	25	



ADAPTOR UNION PP / BRASS FEMALE THREADED			
Code	Size	Packing	
P4802001	20x1/2"	200	
P4802502	25x3/4"	100	
P4802503	25x1"	100	
P4803203	32x1"	80	
P4804004	40x1 1/4"	50	
P4805005	50x1 1/2"	32	
P4806306	63x2"	20	
P4807507	75x2 1/2"	15	
P4809008	90x3"	8	



CONCEALED CHROME -PLATED			
Code	Size	Packing	
P6902501	3/4"	30	



BALL COCK			
Code	Size	Packing	
P7002001	20 mm	100	
P7002501	25 mm	50	
P7003201	32 mm	30	
P7004001	40 mm	20	
P7005001	50 mm	20	
P7006301	63 mm	10	
P7007501	75 mm	5	



ADAPTOR DOUBLE UNION			
Code	Size	Packing	
P5002001	20X1/2"	100	
P5002502	25X3/4"	100	
P5003203	32X1"	50	



WELD IN SADDLE ADAPTOR FEMALE			
Code	Size	Packing	
P5102501	25x1/2"	150	
P5102502	25x3/4"	150	



VALVE			
Code	Size	Packing	
P6002001	20x1/2"	50	
P6002002	20X3/4"	50	
P6002502	25X3/4"	50	
P6003203	32X1"	42	
P6004001	40X1 1/4"	24	
P6005001	50 X1 1/2"	20	



WELD IN SADDLE ADAPTOR MALE			
Code	Size	Packing	
P5202501	25x1/2"	100	
P5202502	25x3/4"	100	



REPAIRING TOOL			
Code	Size	Packing	
P7800001		100	



SADDLE REDUCER			
Code	Size	Packing	
P2503202	32-25 mm	200	



PIN FOR PIPE REPAIR			
Code	Size	Packing	
P7900001		500	



We assure and confirm that all PPR-C Fittings have been produced by PN20-PN25



SPIRAL HOSE			
Code	Size	Packing	
X0602501	25 mm (Red)	100 m	
X0602502	25 mm (Blue)	100 m	



WELDING SOCKET			
Code	Size	Packing	
P7402001	20 mm	20	
P7402501	25 mm	10	
P7403201	32 mm	10	
P7404001	40 mm	5	
P7405001	50 mm	5	
P7406301	63 mm	4	
P7407501	75 mm	1	
P7409001	90 mm	1	
P7411001	110 mm	1	
P7412501	125 mm	1	



PE- Xb CROSS - LINK PIPE			
Code	Size	Packing	
X0201601	16x2.0 mm	160	
X0201603	16x2.2 mm	100	
X0202001	20x1.9 mm	100	
X0202501	25x2.3 mm	50	
X0203201	32x2.9 mm	50	



PIPE CUTTER			
Code	Size	Packing	
P7500002	50-63	1	



PE-Xb CROSS- LINK PIPE WITH OXYGEN BARRIER			
Code	Size	Packing	
X0401601	16x2,0 mm	160	



PIPE CUTTER			
Code	Size	Packing	
P7500003	75-125	1	



PE-RT PIPE			
Code	Size	Packing	
X0301601	16x2,0 mm	160	



WELDING MACHINE SET			
Code	Size	Packing	
P7600001	20-50 mm	5.00	



PE-RT PIPE WITH OXYGEN BARRIER			
Code	Size	Packing	
X0501601	16x2,0 mm	160	



ONLY WELDING MACHINE			
Code	Size	Packing	
P7600002	1500 wat 20-40 mm	1	



PIPE CUTTER			
Code	Size	Packing	
P7500001	16-40	28	



ONLY WELDING MACHINE			
Code	Size	Packing	
P7600003	2000 watt 50-75mm	1	



WELDING MACHINE (BIG)			
Code	Size	Packing	
P7600004	2400 watt 75-125 mm	1	

plastherm®

The Advantages of Plastherm PVC-U Pipe

1) PVC-U waste water pipes are resistant to organic, inorganic acids and alkalines. They keep their physical specifications up to 60 C, does not get deformed.

2) Durable to outer effects as it is a hard PVC and because of its additional materials.

3) The inner surface being smooth creates an ideal liquid flow. So no filthiness as a result of a clogage occurs.

4) PVC-U waste water pipes and fittings' PN is produced with highest quality standart so noise conductivity is minimum and so provides silent environments.

5) PVC-U waste water pipes and fittings' outer protective plating provides long lasting glimmering and esthetic look even for open air installations.

6) PVC-U waste water pipes and fittings are used safely in open air systems due to their high UV ray and stike resistancy.

1) PVC-U Atık Su Boruları Organik, inorganik asitlere ve alkalilere karşı dayanıklıdır 60°C'ye kadar fiziksel özelliklerini korur, deforme olmaz.

2) Sert PVC olması ve katkı malzemelerinin özelliklerinden dolayı dış etkenlere karşı dayanıklıdır.

3) İç yüzeyin pürüzsüz ve düz olması ideal bir akışkanlık sağlar. Bu nedenle tıkanmaya sebebiyet verecek kirliliğin oluşması söz konusu değildir.

4) PVC-U Atık Su Boru ve Ekparçalarının et kalınlıkları standartların en üst seviyesine göre üretildiğinden, ses iletimini minimuma indirir. Bu nedenle sessiz ortamlar sağlar.

5) PVC-U Atık Su Boru ve Ekparçalarının dış koruyucu kaplaması, açık tesisatlar için bile, uzun süre dayanan parlak ve hoş bir görünüm sağlar.

6) PVC-U Atık Su Boru ve Ekparçaları yüksek UV ve darbeye dayanıklı yapılarıyla, dış tesisatlarda güvenle kullanılır.

Important not fore Installation

1. None of the pipes and fittings should be heated for installation.

2. For the easy installation lubricant is applied to the visible part of the gasket and on the outer surface of the pipe's depth to be inserted. Do not use lube oils as a lubricant. Cleaning materials of liquid gel type can be used. The insertion is made on linear axis without forming any angle.

3. Avoid using different materials for mounting the rings on the wall.

1. Hiçbir boru ve ekparça montaj için kesinlikle ısıtılmamalı.

2. Boruların rahat takılabilmesi için contanın görünen yüzeyine ve takılacak borunun girme derinliğine kadar dış yüzeyine kaydırıcı sürülür. Kaydırıcı olarak madeni yağlar kesinlikle kullanılmamalıdır. Sıvı jel türü temizleyici maddeler kaydırıcı olarak kullanılabilir. Açık oluşturmadan düz eksenle itirilerek ekleme yapılır.

3. Kelepçelerin dışında duvara monte için başka malzemeler kullanılmamalı.

Plastherm, PVC-U Pipes & Fittings were produced according to TS-275-1, EN1329-1 / 13.4.199 by Europe and Turkish standard. Plastherm offers best quality and services as well as better competitive prices in domestic and foreign market forever.

Plastherm, PVC-U atık su boru ve ekparçaları TS-275-1, EN1329-1 / 13.4.199 Standartlarına göre üretilmekte olup, ürettiği bütün ürünlerde olduğu gibi PVC-U atık su boru ve ekparçalarında da kalitesi ile iddialıdır.



TS 275 -1 , EN1329 -1

plastherm®



EXCESS WATER PIPE (Typ-1 / 3.2 mm)			
Code	Measure	Pcs / Sack	
V0105001	50/150	150	
V0105002	50/250	100	
V0105003	50/500	20	
V0105004	50/1000	10	
V0105005	50/2000	10	
V0105006	50/3000	10	
V0105007	50/6000	10	
V0107501	75/150	100	
V0107502	75/250	60	
V0107503	75/500	10	
V0107504	75/1000	5	
V0107505	75/2000	5	
V0107506	75/3000	5	
V0107507	75/6000	5	
V0111001	110/150	50	
V0111002	110/250	30	
V0111003	110/500	10	
V0111004	110/1000	5	
V0111005	110/2000	5	
V0111006	110/3000	5	
V0111007	110/6000	5	
V0112501	125/150	25	
V0112502	125/250	20	
V0112503	125/500	10	
V0112504	125/1000	5	
V0112505	125/2000	5	
V0112506	125/3000	5	
V0112507	125/6000	5	
V0116001	160/150	15	
V0116002	160/250	15	
V0116003	160/500	6	
V0116004	160/1000	3	
V0116005	160/2000	3	
V0116006	160/3000	3	
V0116007	160/6000	1	
V0120001	200/150	1	
V0120002	200/250	1	
V0120003	200/500	2	
V0120004	200/1000	1	
V0120005	200/2000	1	
V0120006	200/3000	1	
V0120007	200/6000	1	
V0125001	250/150	1	
V0125002	250/250	1	



EXCESS WATER PIPE (Typ-1 / 3.2 mm)			
Code	Measure	Pcs / Sack	
V0125003	250/500	1	
V0125004	250/1000	1	
V0125005	250/2000	1	
V0125006	250/3000	1	
V0125007	250/6000	1	

EXCESS WATER PIPE (Typ-2 / 2.2 mm)			
Code	Measure	Pcs / Sack	
V0205003	50/500	20	
V0205004	50/1000	10	
V0205005	50/2000	10	
V0205006	50/3000	10	
V0205007	50/6000	10	
V0207503	75/500	10	
V0207504	75/1000	5	
V0207505	75/2000	5	
V0207506	75/3000	5	
V0207507	75/6000	5	
V0211003	110/500	10	
V0211004	110/1000	5	
V0211005	110/2000	5	
V0211006	110/3000	5	
V0211007	110/6000	5	
V0212503	125/500	10	
V0212504	125/1000	5	
V0212505	125/2000	5	
V0212506	125/3000	5	
V0212507	125/6000	5	
V0216003	160/500	6	
V0216004	160/1000	3	
V0216005	160/2000	3	
V0216006	160/3000	3	
V0216007	160/6000	1	
V0220003	200/500	2	
V0220004	200/1000	1	
V0220005	200/2000	1	
V0220006	200/3000	1	
V0220007	200/6000	1	
V0225003	250/500	1	
V0225004	250/1000	1	
V0225005	250/2000	1	
V0225006	250/3000	1	
V0225007	250/6000	1	

plastherm®



OPEN ELBOW 45°			
Code	Measure	Pcs / Sack	
V0305001	50	200	
V0307501	75	100	
V0311001	110	40	
V0312501	125	25	
V0316001	160	15	
V0320001	200	8	



SINGLE BRANCHE TEE 87°			
Code	Measure	Pcs / Sack	
V0605001	50x50	150	
V0607501	75x50	75	
V0607502	75x75	50	
V0611001	110x50	35	
V0611002	110x75	30	
V0611003	110x110	20	
V0612503	125x110	10	
V0612504	125x125	5	
V0616003	160x110	6	
V0616005	160x160	5	



CLOSE ELBOW 87°			
Code	Measure	Pcs / Sack	
V0405001	50	200	
V0407501	75	75	
V0411001	110	30	
V0412501	125	20	
V0416001	160	16	
V0420001	200	4	



DOUBLE BRANCHE TEE 45°			
Code	Measure	Pcs / Sack	
V0705001	50x50	75	
V0707501	75x50	50	
V0707502	75x75	30	
V0711001	110x50	25	
V0711002	110x75	6	
V0711003	110x110	5	
V0712503	125x110	5	
V0712504	125x125	5	
V0716001	160x50	10	
V0716003	160x110	5	



SINGLE BRANCHE TEE 45°			
Code	Measure	Pcs / Sack	
V0505001	50x50	100	
V0507501	75x50	50	
V0507502	75x75	40	
V0511001	110x50	30	
V0511002	110x75	25	
V0511003	110x110	15	
V0512501	125x50	20	
V0512502	125x75	15	
V0512503	125x110	5	
V0512504	125x125	5	
V0516003	160x110	5	
V0516004	160x125	4	
V0516005	160x160	4	



REDUCING BUSH			
Code	Measure	Pcs / Sack	
V0807501	75x50	150	
V0811001	110x50	75	
V0811002	110x75	75	
V0812501	125x50	50	
V0812502	125x75	50	
V0812503	125x110	40	
V0816003	160x110	40	
V0816004	160x125	35	
V0820003	200x110	15	
V0820004	200x160	15	

plastherm®



CLEANING TEE			
Code	Measure	Pcs / Sack	
V0907501	75	50	
V0911001	110	20	
V0912501	125	10	
V0916001	160	5	



PIPE EN PLUG			
Code	Measure	Pcs / Sack	
V1605001	50	750	
V1607501	75	250	
V1611001	110	125	
V1612501	125	100	
V1616001	160	100	



S SIPHON			
Code	Measure	Pcs / Sack	
V1007501	75 mm (Elbow 90°)	40	
V1010001	110 mm (Elbow 90°)	10	
V1110001	110 mm (Elbow 45°)	10	



CORNERED RAIN GUTTER			
Code	Measure	Pcs / Sack	
V1816001	160 mm (4 m Length)	4	



SOCKET JOINT COLLAR			
Code	Measure	Pcs / Sack	
V1205001	50	250	
V1207501	75	100	
V1211001	110	40	
V1212501	125	30	
V1216001	160	15	
V1220001	200	12	



CORNERED END CAP			
Code	Measure	Pcs / Sack	
V2016001	160 mm	200	



BARACELET WITH COVER			
Code	Measure	Pcs / Sack	
V1305001	50	250	
V1307501	75	200	
V1311001	110	100	
V1312501	125	80	
V1316001	160	40	
V1320001	200	40	



CORNERED SOCKET FOR GUTTER			
Code	Measure	Pcs / Sack	
V2116001	160 mm	50	



GUTTER INSIDE CORNER			
Code	Measure	Pcs / Sack	
V2216001	160 mm	30	



FLOOR TRAP			
Code	Measure	Pcs / Sack	
V1500001	Short	24	
	125x70x50x50x50		
V1500002	(Tall)	15	
	125x70x50x50x50		



RAIN GUTTER DOWNWARDS			
Code	Measure	Pcs / Sack	
V2407501	160x75	30	



CORNERED HANGER			
Code	Measure	Pcs / Sack	
V2716001	160 mm	80	



Certificates



Certificates

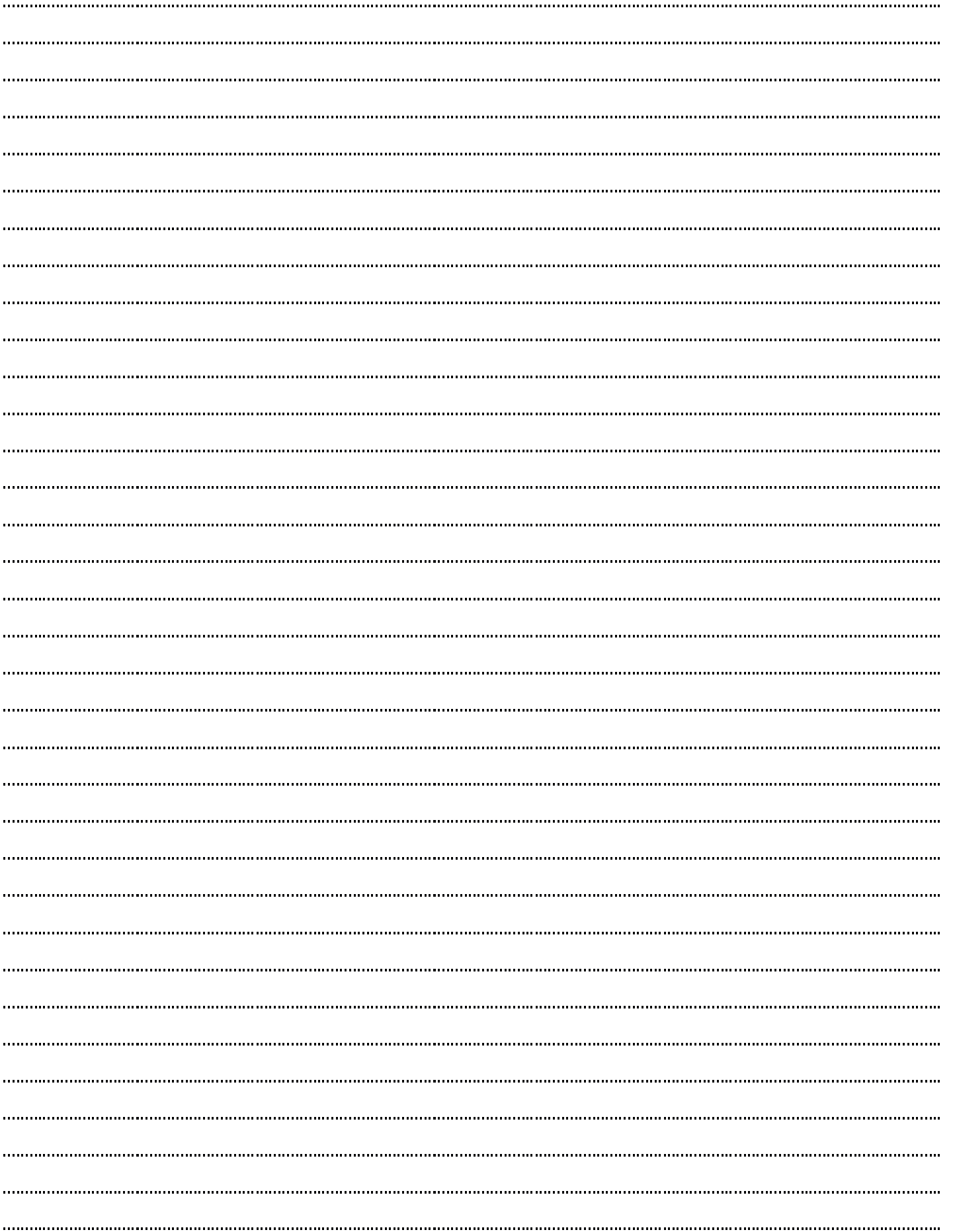

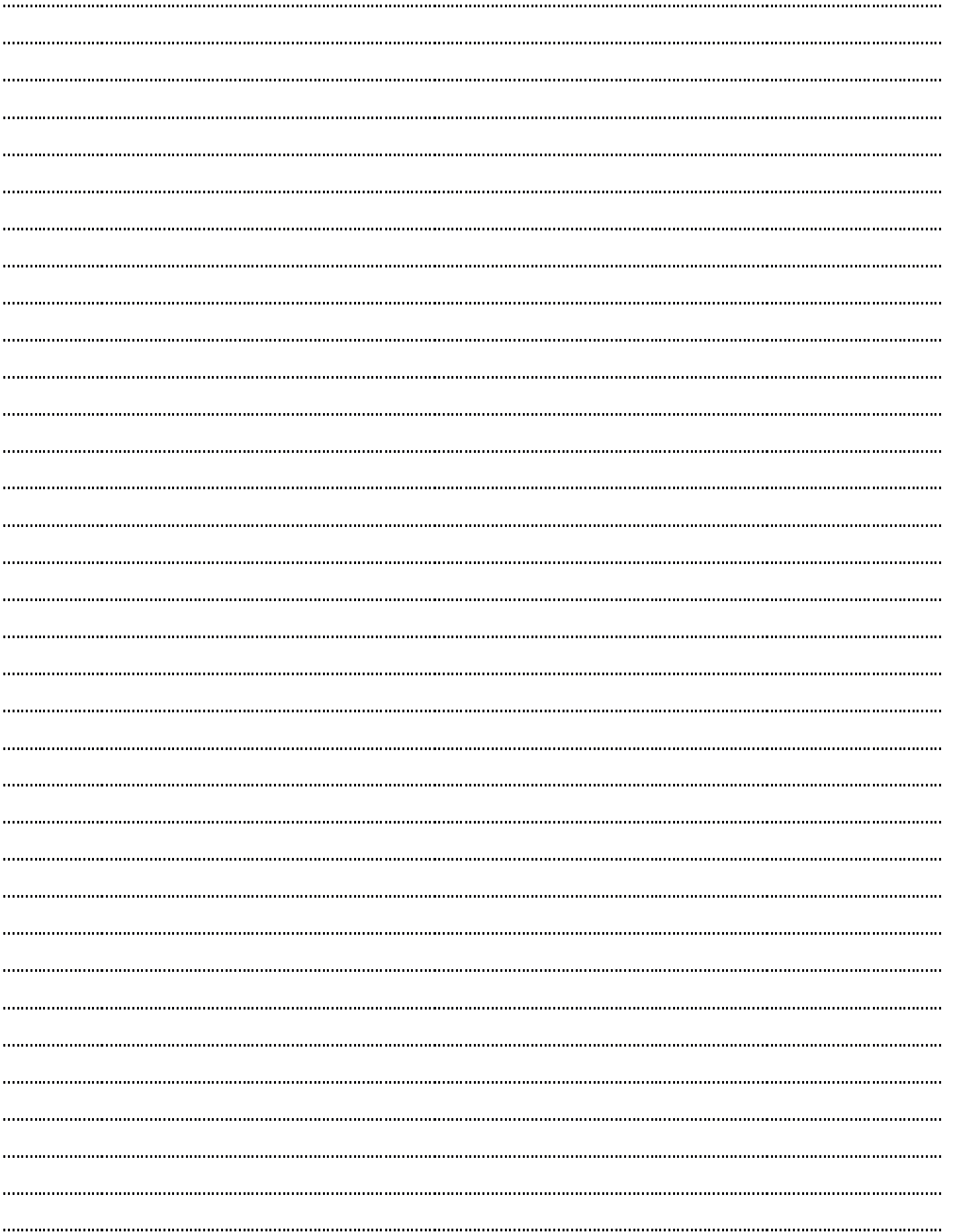



Aurasia